

# Service Assured Solutions

2022 Catalog









Your Network's Edge®





# Table of Contents

<b>Company Profile .....</b>	<b>2</b>		
<b>Service Assured Access Solutions for Service Providers .....</b>	<b>4</b>	<b>Service Assured Networking Solutions for Critical Infrastructure .....</b>	<b>13</b>
   Wholesale Services		   Utilities	
Wholesale Networking .....	5	Power Utility Communications .....	14
   Business Services		Water Utility Communications .....	17
Carrier Ethernet for L2 VPNs .....	6	Oil and Gas Utility Communications .....	19
Industrial IoT Backhaul with Edge Computing .....	7	   Transportation	
RADinsight PM .....	8	Highway Communications .....	20
vCPE .....	9	Train and Metro Communications .....	21
TDM Migration .....	10	Air-Traffic Control Communications .....	23
   Mobile Services		   Government	
4G/5G Mobile xHaul .....	11	Smart City Communications .....	25
Timing Synchronization for Mobile Networks .....	12	First Responders and Military Communications ...	27
		<b>RAD Products .....</b>	<b>28</b>
		<b>RAD Services .....</b>	<b>56</b>
		<b>Partner Program .....</b>	<b>61</b>

# Pioneering Telecom Access Solutions

As a global telecom access solutions vendor, RAD is committed to enabling service providers and critical infrastructure operators to evolve any service over any network. By keeping at the forefront of pioneering technologies and engaging in **co-innovation** with our customers, we strive to help service providers move up the value chain at a pace that is right for them, while offering their end-customers and network operators added value – be it in **EADs** and **network edge solutions**, **industrial IoT**, or **5G xHaul**.



## Service Providers

Ensure fast service setup, easy upgrades and flexible L2 connectivity and 5G xHaul with RAD's Service Assured Access solutions.

## Critical Infrastructure

OT/IT convergence, industrial IoT backhaul with edge computing and cyber-secure operational WAN with RAD's Service Assured Networking solutions.

With over 40 years of innovation, a significant worldwide presence in over 150 countries and an installed base of more than 17 million network elements, RAD has a proven track record of delivering value and addressing our customers' needs.

RAD is a member of the \$1.5 billion RAD Group of companies, a world leader in telecommunications solutions.





# Service Providers

Ensure fast service setup, easy upgrades and flexible L2 connectivity and 5G xHaul with RAD's Service Assured Access (SAA) solutions.

RAD's solutions allow wholesale, business and mobile service providers to enrich their business service offering as they add value off the edge to businesses transitioning to the cloud.

In addition, RAD's solutions deliver edge virtualization and cloud access with performance assurance, service flexibility and operational efficiency, as well as 5G xHaul.

Key SAA solutions include:

- Market-leading EAD portfolio for delivering Carrier Ethernet services with SLA assurance, end-to-end visibility and life-cycle management over any access
- Ultra-fast service rates and setup with zero-touch automation and LTE broadband uplinks. In addition, license-enabled remote upgrades, from 1G up to 100G, provide that much needed flexibility
- At-a-glance views of problem areas affecting service quality, across the entire traffic path using RADinsight PM
- Programmable cell-site gateways for fast rollouts of 5G deployments with fronthaul/midhaul/backhaul support and future 5G upgrades
- Seamless migration from TDM to IP, supporting an existing installed base and services, while introducing next-gen communications

# Wholesale Networking

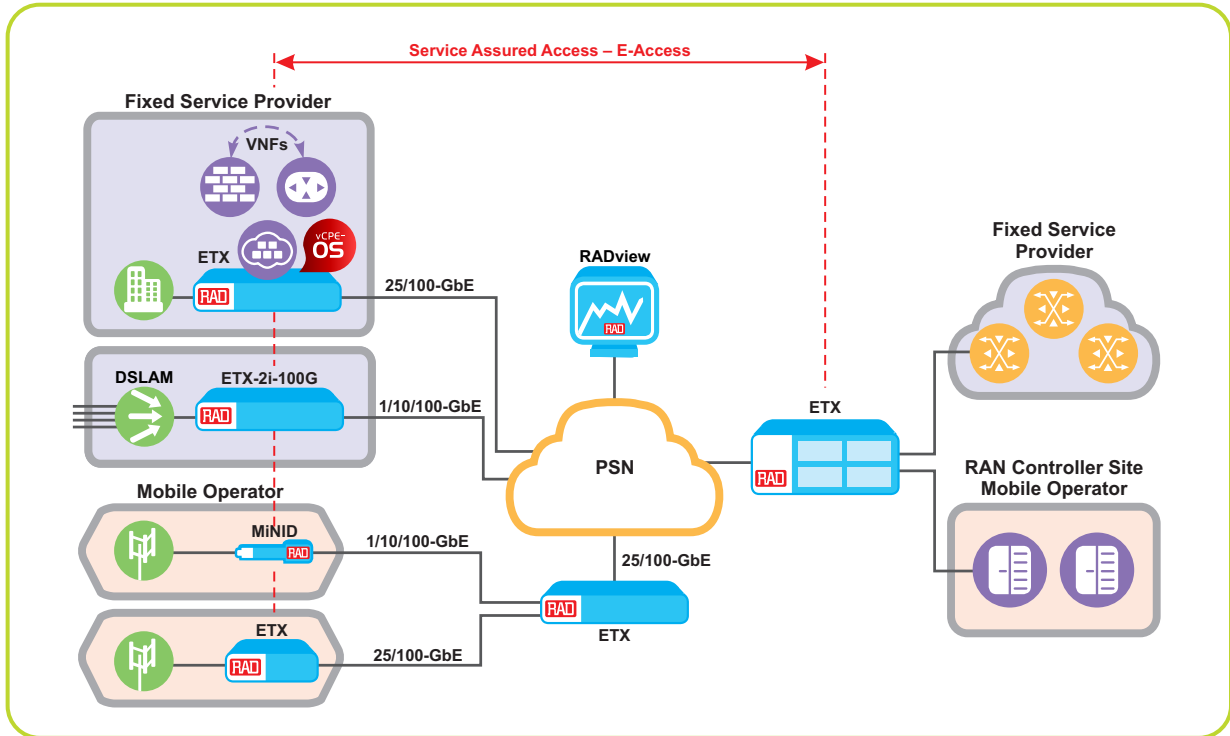

## Your Benefits:

- Provide wholesale Carrier Ethernet transport services to multiple service providers with complete visibility and controlled service hand-off between multiple networks
- Demarcation for business and mobile services, and broadband access node (e.g., DSLAM) backhaul over the same transport network
- Provide SLA-based backhaul all the way to the end-customer site, cell site or POP
- MEF-certified Carrier Ethernet 3.0 E-Access support with single-CoS and/or multiple-CoS EVC/OVC for standards-based carrier-to-carrier connectivity
- Seamless connection between networks with 1-GbE, 10-GbE and 100G E-NNI interfaces with optional redundancy
- Enhance wholesale offering with VNF-based, managed, value-added services
- Double fiber capacity while avoiding costly new fiber/transceiver deployments with BiDi QSFP 100G/400G adaptors



**ETX-2i-100G**  
100G EAD



**BiDi QSFP Adaptor**  
100G/400G Dual to Single Fiber Adaptor



**ETX-2**  
Carrier Ethernet Demarcation



**MiNID**  
Miniature Programmable  
Network Interface Device



**RADview**  
Management and  
Domain Orchestration



# Carrier Ethernet for L2 VPNs

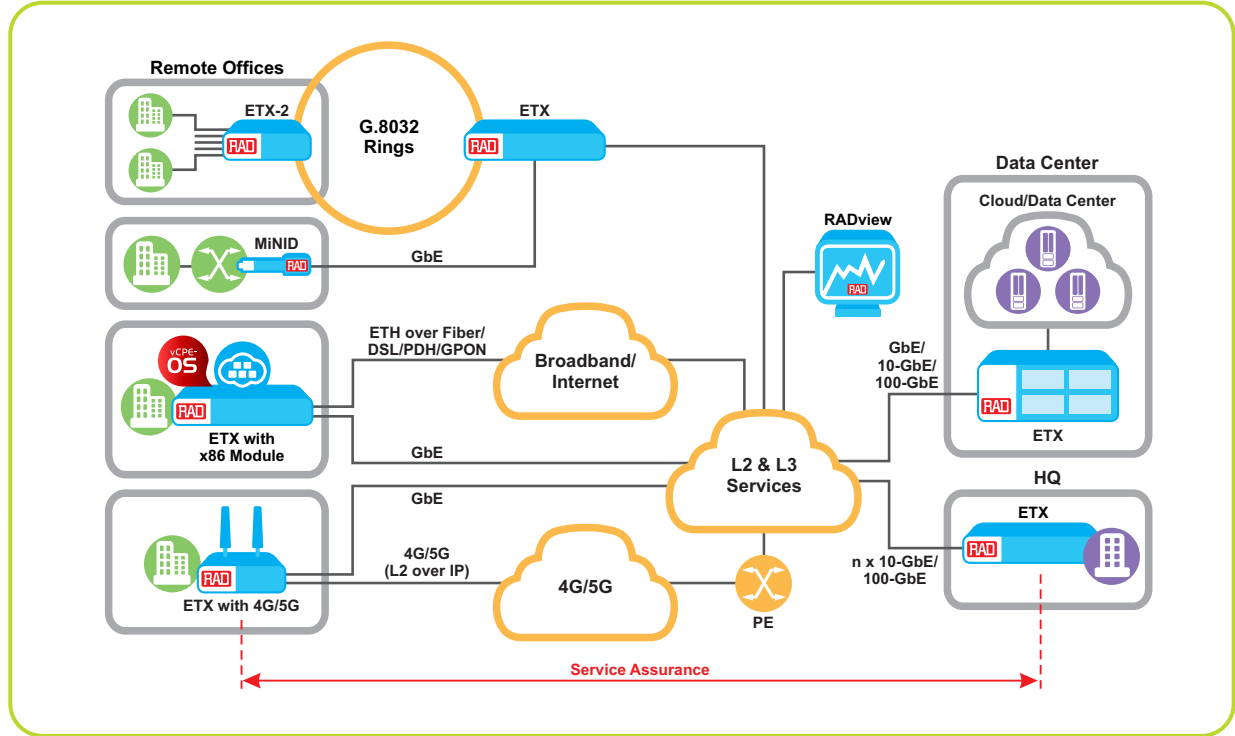

### Your Benefits:

- Easily plan, deploy, provision, and maintain SLA-based business services over any access: fiber/copper/TDM/mobile
- Carrier Ethernet demarcation and aggregation switch up to 100G
- MEF 3.0-certified with standard NETCONF/YANG northbound interfaces
- Cost-effective aggregation with dynamic edge support for monitoring and policing vCPE functionality at the customer edge for introduction of value-added services
- Enhanced service provisioning, visibility and reporting using RADview Service Manager and RADview Performance Monitoring portal
- Double fiber capacity while avoiding costly new fiber/transceiver deployments with BiDi QSFP 100G/400G adaptors



**ETX-2/ETX-2i**  
EADs with x86 Module, LTE/5G and Broadband Options



**BiDi QSFP Adaptor**  
100G/400G Dual to Single Fiber Adaptor



**ETX-2/ETX-2i**  
Carrier Ethernet Demarcation



**MiNID**  
Miniature Programmable Network Interface Device



**RADview**  
Management and Domain Orchestration



# Industrial IoT Backhaul with Edge Computing

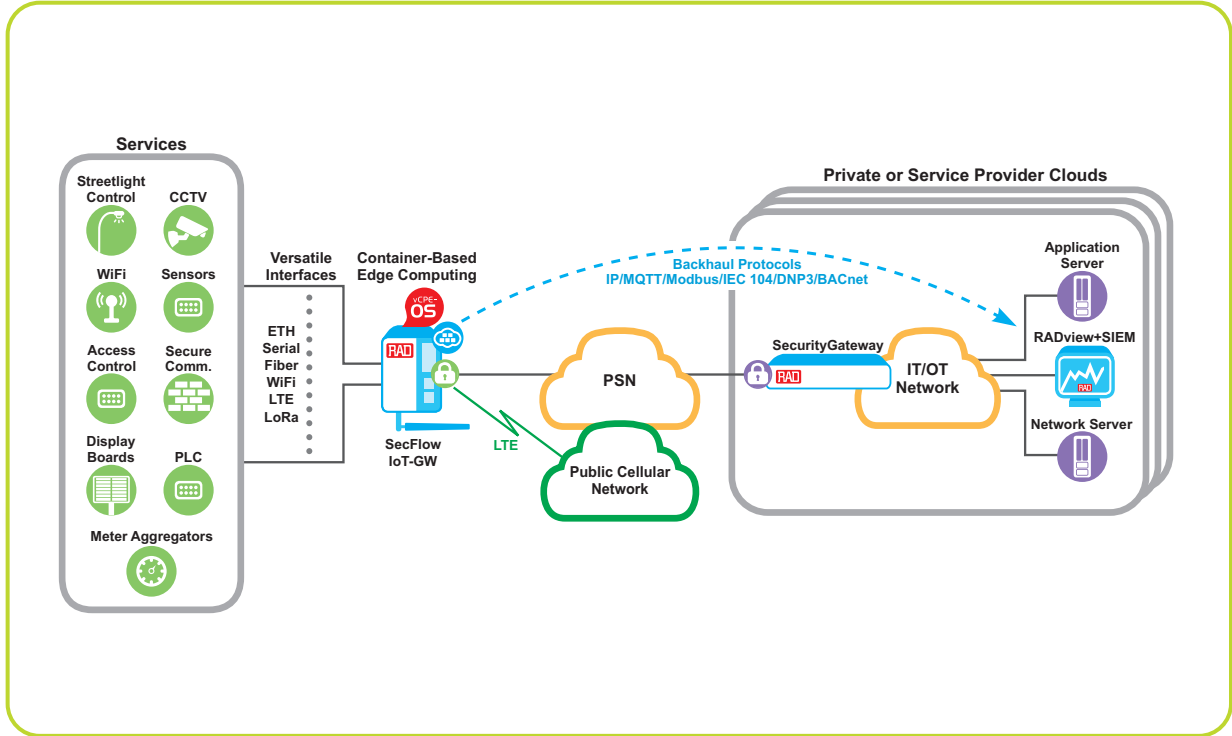

## Your Benefits:

- Offer competitive IoT services for monitoring and automation devices, Smart City projects, etc.
- Virtual environment for user-tailored applications allows customers to add new applications on top of SecFlow devices
- Zero-touch provisioning, enhanced
- cyber security (IPsec, PKI, FW, IDS/IPS, SIEM)
- Seamless communications over fiber optics, radio links and 2G/3G/LTE cellular links
- Secure remote access for end-user device management
- Integrated IEC 61131-3 RTU/PLC
- Integrated PLC functionality and LoRaWAN gateway reduces the number of devices in the network
- Transparent delivery of SCADA, protocol conversion and terminal server
- Complies with IEC 61850-3 and IEEE 1613 environmental standards



**SecFlow**  
Industrial IoT Gateway  
with Edge Computing



**vCPE-OS**  
Open Carrier-Class  
Operating System



**SecurityGateway**  
VPN Aggregator, Router  
and Firewall



**RADview**  
Management and Domain  
Orchestration



# RADinsight PM: LAN to Cloud Performance Monitoring

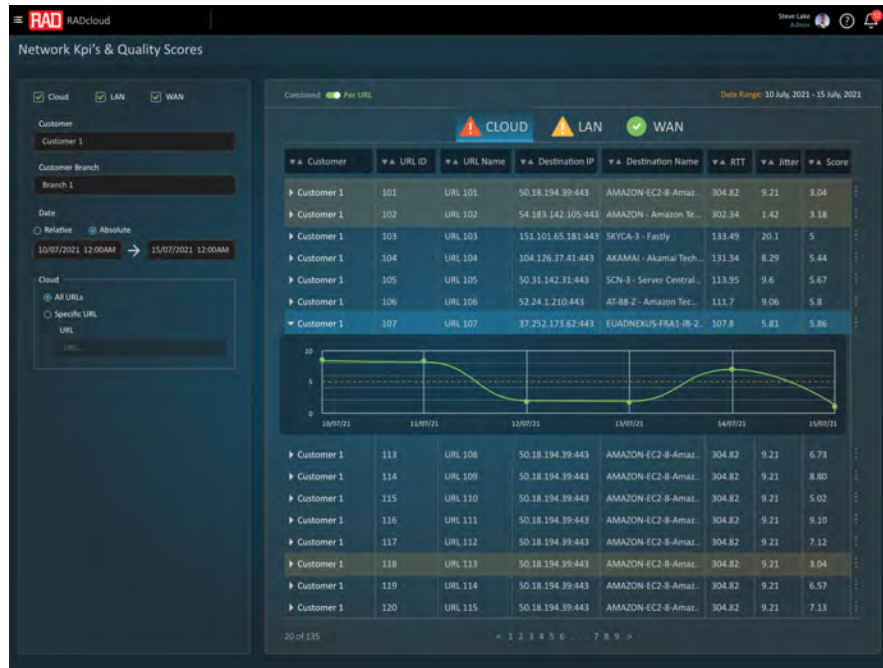

## Your Benefits:

- At-a-glance views of problem areas affecting service quality, across the entire traffic path: Customer LANs, service provider's WAN and the internet/cloud
- Replaces long, service-affecting troubleshooting procedures
- and saves on call center costs, truck rolls and unnecessary CPE replacements
- Applies to existing EAD installed base; no hardware or software upgrade needed
- Access to contextual, meaningful insights and history data; can be used by CSP personnel or as a business-customer self-service portal
- Subscription-based cloud service



**ETX-2/ETX-2i**  
1G/10G/100G Carrier  
Ethernet Demarcation



**ETX-203**  
Carrier Ethernet  
Demarcation



**RADinsight**  
LAN to Cloud Performance  
Monitoring



# vCPE

## 1 uCPE and pCPE for L3 VPN

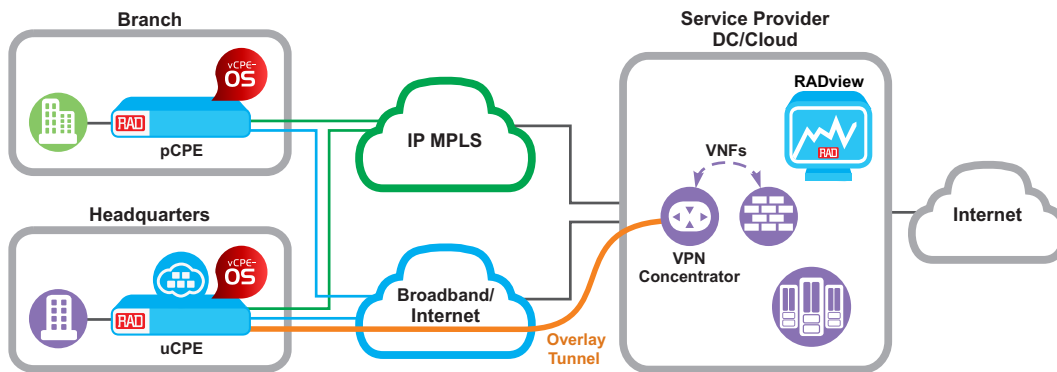

### Your Benefits:

- Disaggregation: Freedom to choose any vCPE hardware, per branch site requirements, with a common operating system in all vCPEs to minimize integration efforts and reduce costs
- Virtualization: Enrich business offerings by hosting value-added VNFs and CNFs (Container Network Functions) at the customer or network edge
- Embedded advanced router with NG-firewall reduces TCO by eliminating the need to purchase third-party router VNF
- Expand L3 VPN services over fixed/mobile broadband networks with secure overlay tunnels to enhance connectivity and cost options
- Automation with full life-cycle support, ZTP, SDN/NETCONF support, and more, using the RADview Domain Orchestrator



ETX-1p, SecFlow-1p pCPE Platforms



ETX-2v uCPE Platforms



vCPE-OS Open Carrier-Class Operating System



RADview Management and Domain Orchestration

# TDM Migration

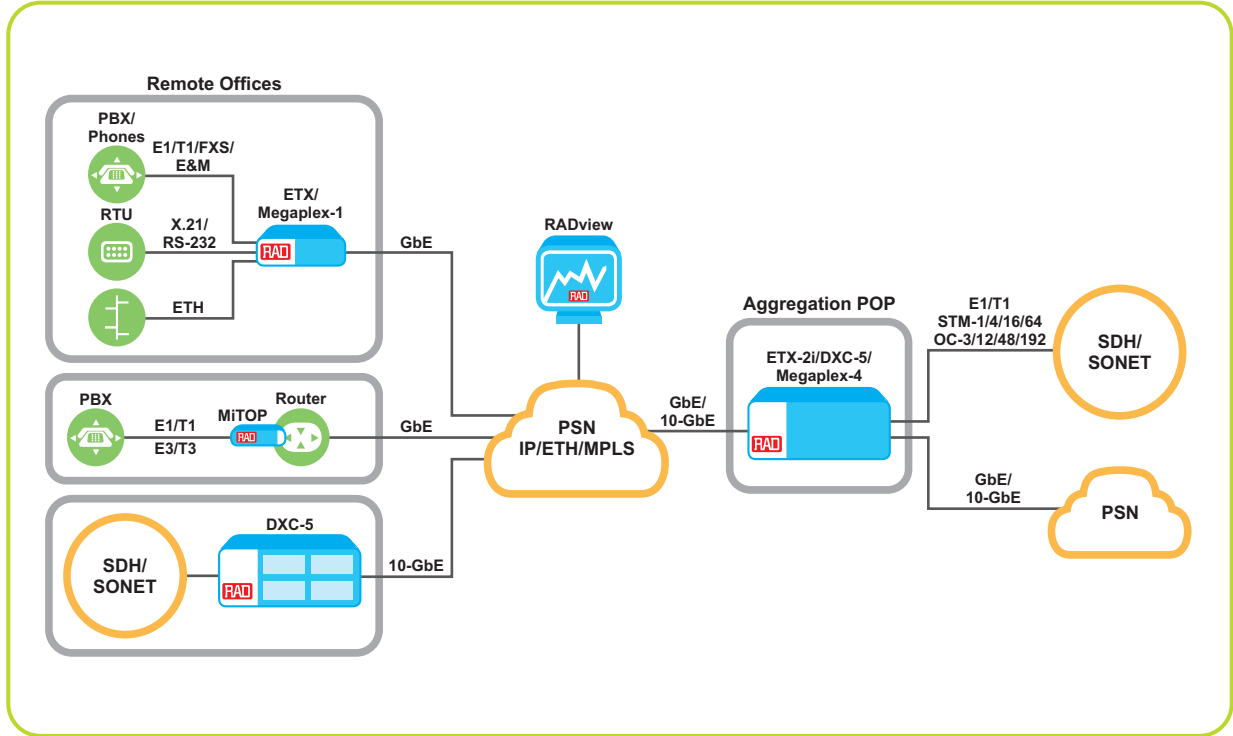

## Your Benefits:

- Maintain legacy TDM services over new packet network to keep revenue flow and customer loyalty
- Enable alternative providers to add leased lines to their service portfolio to attract new customers
- Support heterogenic First Mile footprint requiring CPE support for DSL/EFM, Ethernet, GPON connections, and flexibility in PWE termination options: Customer site-to-customer site, customer site-to-POP/network, POP-to-POP
- Allow a single transport network for IP/Ethernet and TDM services to simplify operations and lower TCO



**Megaplex-4**  
Next-Generation Multiservice Networking Node



**DXC-5**  
High Capacity Hybrid Cross Connect



**ETX-2/ETX-2i**  
Carrier Ethernet Demarcation



**MiTOP-E1/T1, E3/T3**  
Smart SFP-Format TDM Pseudowire Gateways



**RADview**  
Management and Domain Orchestration

# 4G/5G Mobile xHaul

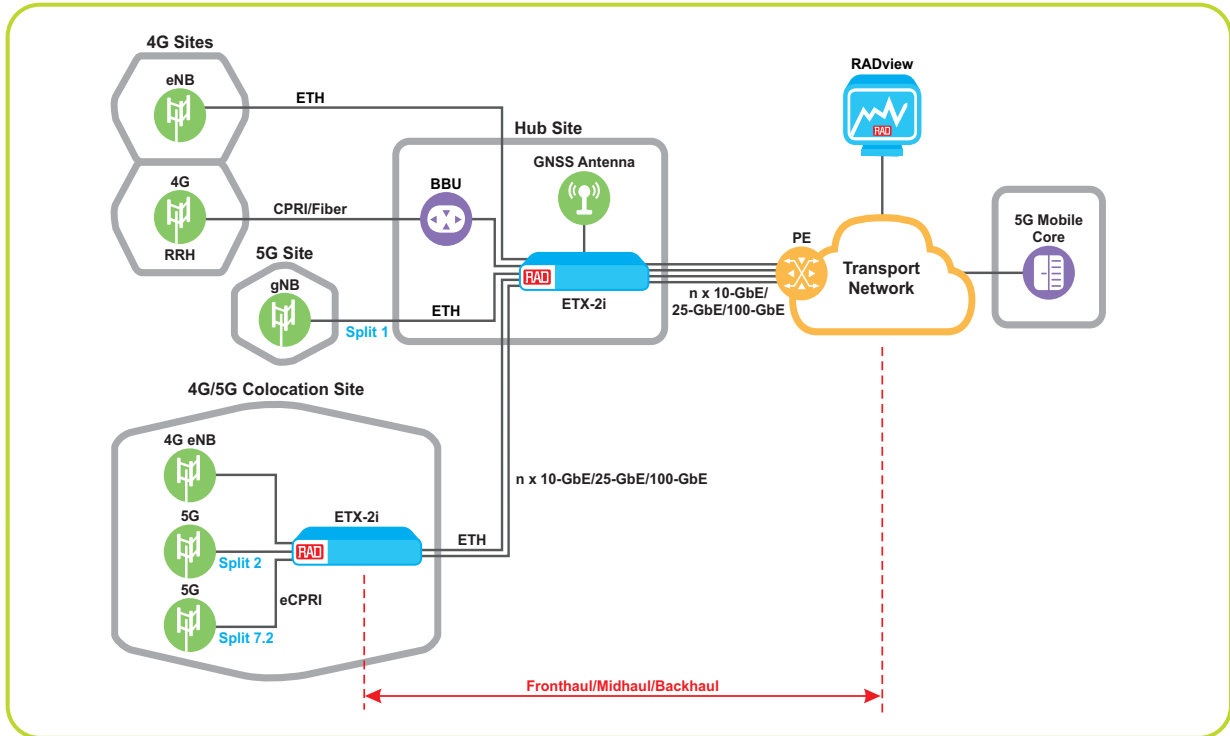

## Your Benefits:

- Fast rollouts of 5G deployments with in-field future upgrades to meet new requirements
- CSG for multiple 5G RAN splits and collocated 4G/5G sites
- Highly efficient 4G/5G aggregation: 10G, 25G and 100G
- Support wholesale and direct MNO applications
- Fixed-mobile convergence: Collocated mobile and fixed broadband sites
- Multi-CoS Carrier Ethernet/IP backhaul with service management and OAM-based diagnostics
- 1588 PTP (GM, BC Class B, TC) with integrated GNSS receiver, eSync-E for timing synchronization
- L2, L3-based fronthaul/midhaul/backhaul performance monitoring for multiple network slices and for network sharing
- Small form factor to meet space and power supply restrictions
- Ruggedized enclosure for outdoor installations



**ETX-2/ETX-2i**  
Carrier Ethernet  
Cell-Site Gateways up to 100G



**ETX-2i-10G Clamshell**  
Ruggedized Cell-Site  
Gateway



**RADview**  
Management and  
Domain Orchestration

# Timing Synchronization for Mobile Networks

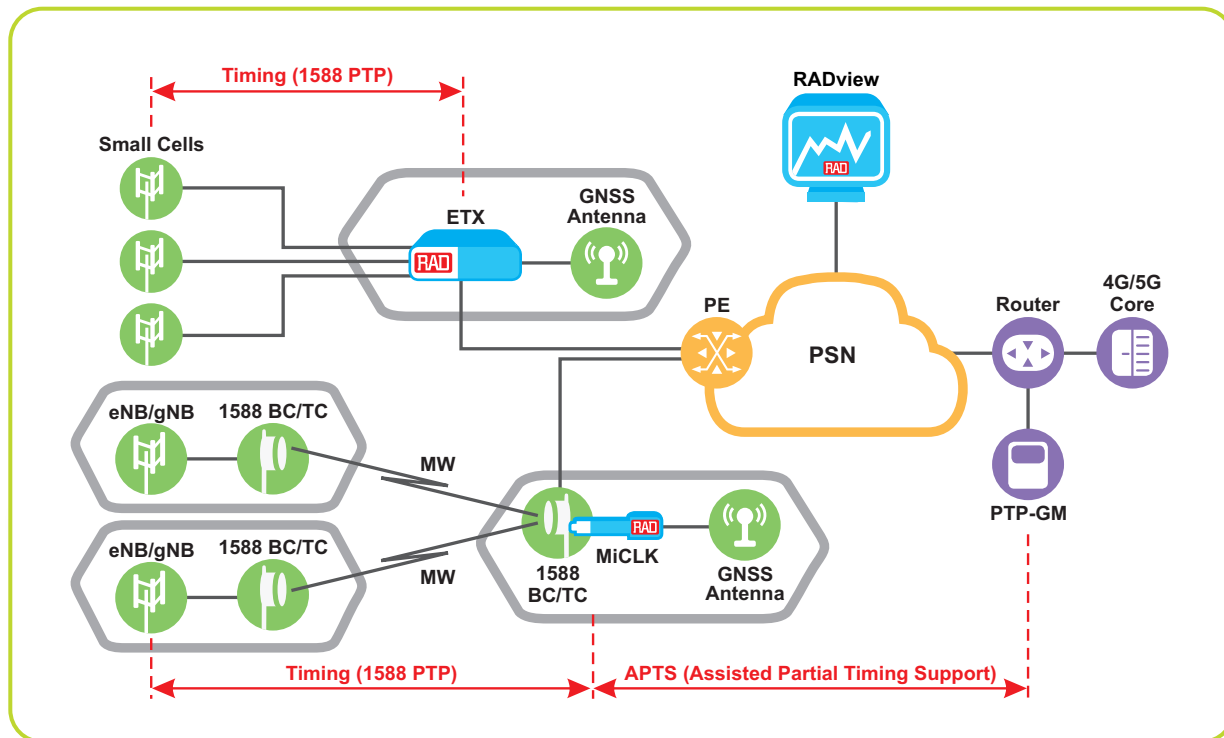

## Your Benefits:

- Addressing stringent timing requirements (frequency/phase) for LTE/LTE-A/5G macro and small cells with a fully featured PTP Grandmaster:
  - ETX-2 in a local POP/hub
  - MiCLK unique SFP plugged into an aggregation switch
- Cost efficiency by bringing PTP Grandmaster closer to the cell site
- Built-in GNSS receiver
- Full network coverage, even in underground and indoor installations
- No need to install GNSS antenna on every cell site; avoid spoofing and jamming
- Fits existing installed base – no need for CapEx investments in retrofitting network with 1588 BC/TC support across the entire path
- Robust GNSS (GPS/GLONASS) backup – time holdover for 72 hours, using Sync-E or 1588 frequency references from the network (Assisted Partial Timing Support)



**ETX-2/ETX-2i**  
Carrier Ethernet Demarcation



**MiCLK**  
1588 Grandmaster on an SFP



**RADview**  
Management and Domain Orchestration



# Critical Infrastructure

Industrial IoT with edge computing and cyber-secure operational WAN, using RAD's Service Assured Networking solutions.

RAD provides Service Assured Networking (SAN) solutions that ensure seamless migration to packet switched communication networks and applications. We address all communication needs of the utilities, transportation and government sectors with always-on reliability and mission-critical protection. We offer best-of-breed reliability tools. Our SAN solutions are used for cyber-secure industrial IoT (IIoT) and operational WANs, fog/edge computing, TDM to packet migration, distance Teleprotection and distribution automation, as well as Smart/Safe City deployments.

Key SAN solutions include:

- Secure networking for digital transformation to allow fast, secure and economical deployment of thousands of new remote IIoT sites
- Multiservice, packet and PoE-intensive OT WANs, enabling easy migration from TDM to PSNs
- Seamless communications over fiber optics, radio links, 2G/3G/LTE/5G cellular links, and leased lines
- Extensive security suite includes SCADA-aware firewall, intrusion prevention, man-in-the-middle attack prevention, encryption, device connection control, event logger, and anomaly detection

# Power Utility Communications

## 1 Industrial IoT Backhaul for Distribution Automation and Smart Metering

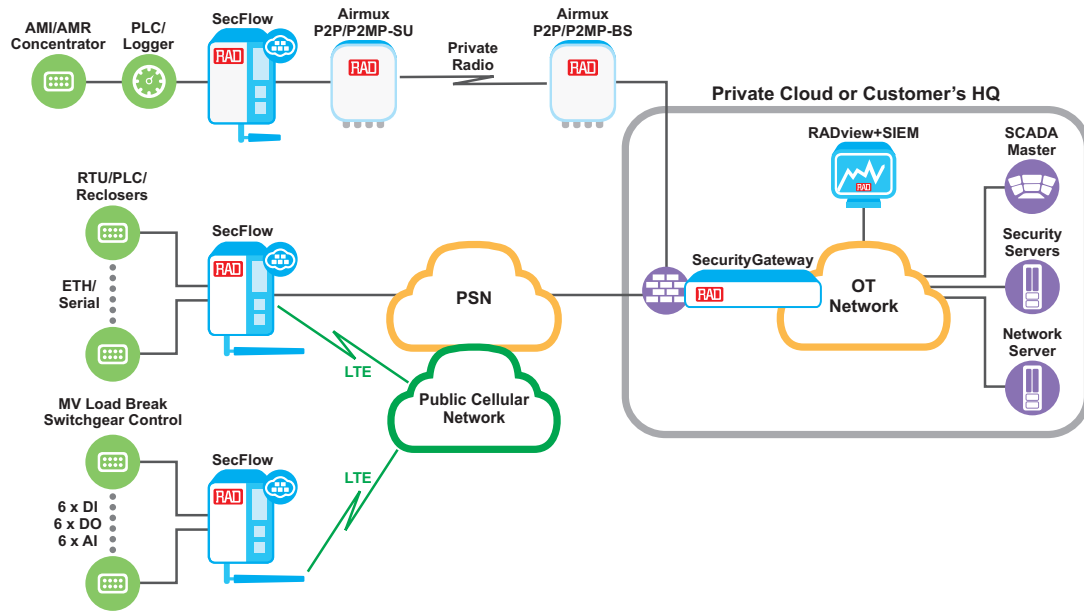

### Your Benefits:

- A comprehensive and secure solution addressing communications to secondary substations, metering and distribution automation
- Integrated IEC 61131-3 RTU/PLC
- Integrated LoRaWAN gateway
- Virtual environment for user-tailored applications allows customers to add new applications on top of SecFlow devices
- Zero-touch provisioning, enhanced cyber security (IPsec, PKI, FW, IDS/IPS, SIEM)
- Seamless communications over fiber optics, radio links, 2G/3G/LTE/5G cellular links, and leased lines from a telecom service provider
- Secure remote access for end-user device management
- Transparent delivery of SCADA, protocol conversion and terminal server
- Complies with IEC 61850-3 and IEEE 1613 environmental standards
- Point-to-multipoint radio connectivity supports high capacity mission-critical traffic over licensed and unlicensed sub-6 GHz bands



**SecFlow**  
Industrial IoT Gateway with Programmable Logic Controller



**SecurityGateway**  
VPN Aggregator, Router and Firewall



**Ceragon/Airmux**  
Wireless Transport Platform



**RADview**  
Management and Domain Orchestration



## 2 Multiservice Operational WAN

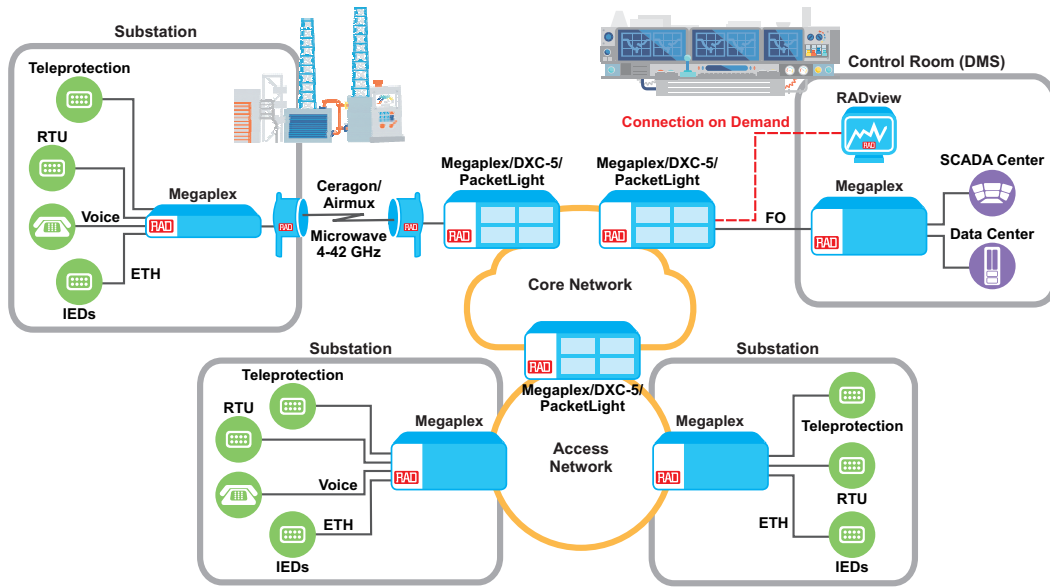

### Your Benefits:

- Powerful cross-generation TDM, MPLS and Ethernet capabilities, including TDM DSO cross connect and SDH/SONET, Carrier Ethernet with OAM and assured QoS, TDM pseudowire, Ethernet over NGPDH/SDH/SONET
- Complete cyber suite, including encryption, authentication and authorization
- Easy connectivity of all services including Teleprotection over either SDH/SONET or a packet network
- Supports analog and digital data and voice devices, as well as Ethernet IEDs, with versatile rates from DSO (time slot) up to STM-64/OC-192 or 10-GbE
- Guaranteed smooth migration to PSNs based on hybrid design for reduced latency and better resiliency
- Point-to-point and point-to-multipoint radio connectivity supports high capacity mission-critical traffic over licensed and unlicensed bands



**Megaplex**  
Next-Generation Multiservice Networking Node



**DXC-5**  
High Capacity Hybrid Cross Connect



**Ceragon/Airmux**  
Wireless Transport Platform



**PacketLight-1000/2000/4000**  
Complete Solutions for WDM/OTN and Dark Fiber Applications



**RADview**  
Management and Domain Orchestration





### 3 Packet Operational WAN

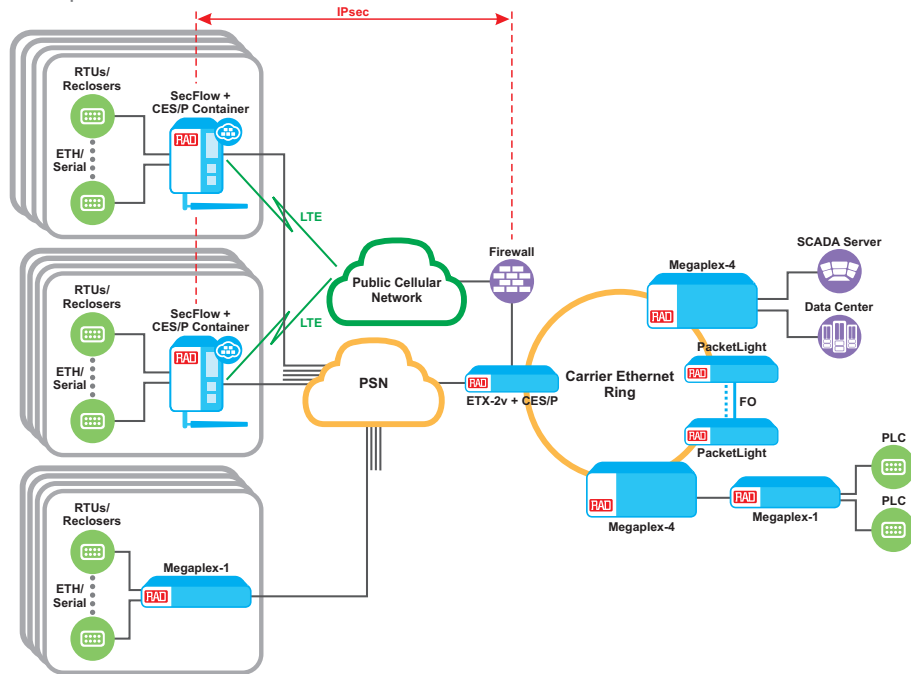

#### Your Benefits:

- Supports Ethernet-based communications for mission-critical automation traffic within the substation and between SCADA control centers
- Multiple elements on each ring/sub-ring
- Complies with IEC 61850-3 and IEEE 1613 environmental standards
- Legacy communications using pseudowire emulation (PWE) with hitless PWE redundancy
- Optional PoE+
- Ring protection: Standard with G.8032 and proprietary with fast recovery time (< 10 ms for PF\_Ring™)
- Supports installation in harsh environments, IEEE 1613 and/or IEC 61850-3 (optional for specific devices)
- Secure remote access for end-user device management
- Transparent delivery of Ethernet and serial SCADA protocols



**Megaplex-4**  
Next-Generation Multiservice Networking Node



**Megaplex-1**  
Multiservice Pseudowire Access Gateway



**DXC-5**  
High Capacity Hybrid Cross Connect



**PowerFlow**  
Managed Ruggedized Ethernet Switch with Power over Ethernet



**PacketLight-1000/2000**  
Complete Solutions for WDM/OTN and Dark Fiber Applications



**RADview**  
Management and Domain Orchestration

# Water Utility Communications

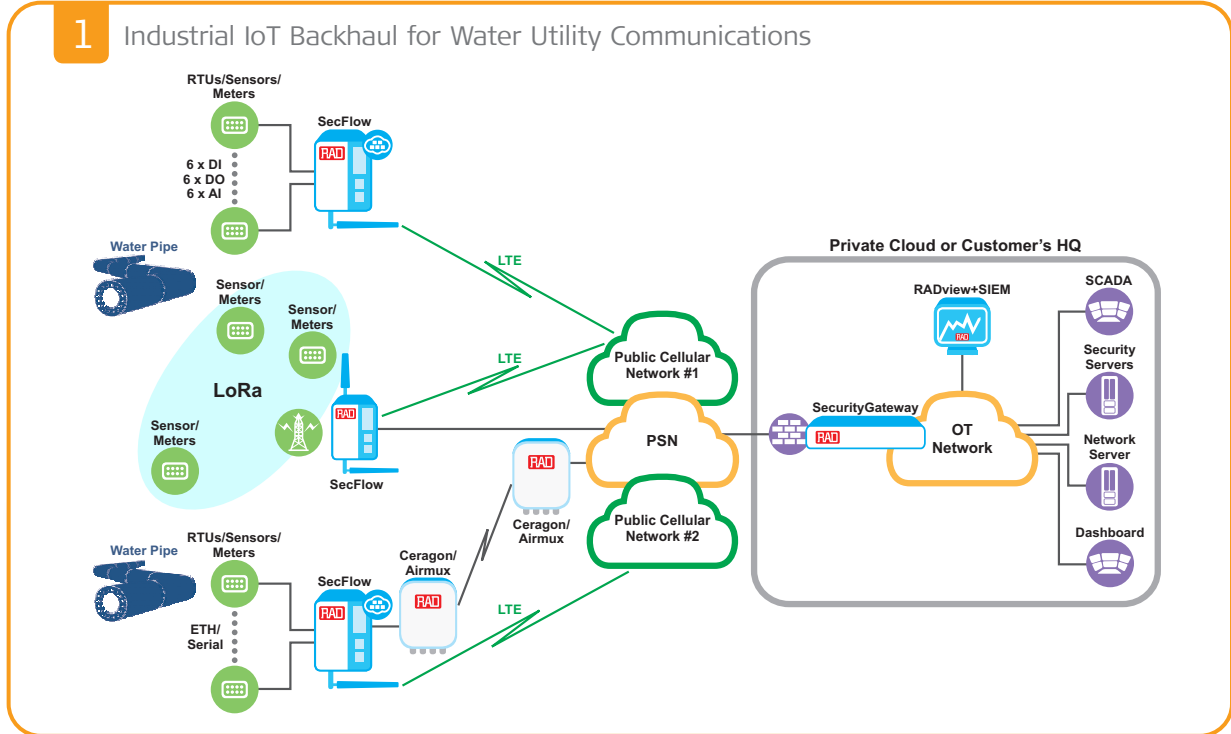

## Your Benefits:

- A comprehensive and secure solution addressing communications for water monitoring and automation devices, sensors, pumps, etc.
- Integrated IEC 61131-3 RTU/PLC
- Integrated LoRaWAN gateway
- Virtual environment for user-tailored applications allows customers to add new applications on top of SecFlow devices
- Zero-touch provisioning, enhanced cyber security (IPsec, PKI, FW, IDS/IPS, SIEM)
- Seamless communications over fiber optics, radio links, 2G/3G/LTE/5G, private cellular links, and leased lines from a telecom service provider
- Secure remote access for end-user device management
- Transparent delivery of SCADA, protocol conversion and terminal server
- Point-to-multipoint radio connectivity supports high capacity mission-critical traffic over licensed and unlicensed sub-6 GHz bands



**SecFlow**  
Industrial IoT Gateway with Programmable Logic Controller LoRaWAN Server



**SecurityGateway**  
VPN Aggregator, Router and Firewall



**Ceragon/Airmux**  
Wireless Transport Platform



**RADview**  
Management and Domain Orchestration



## 2 Operational WAN for Water Utility Communications

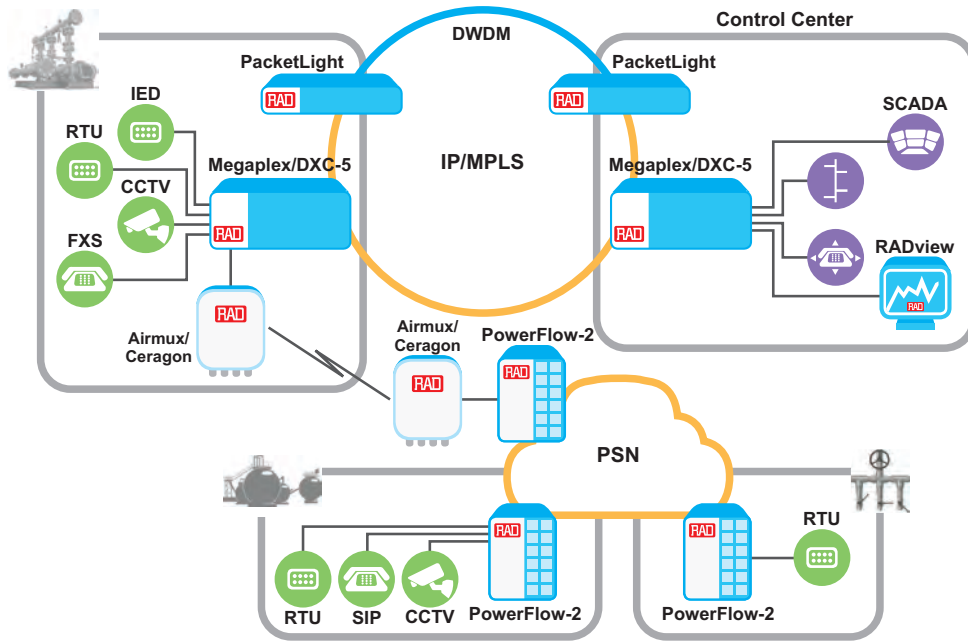

### Your Benefits:

- Cyber-secure SCADA connectivity for water monitoring and automation devices, sensors, pumps, surface and groundwater availability tracking devices, etc.
- Supports all communication needs, including SCADA protocols, voice and new packet services (CCTV, VoIP, etc.)
- Multiservice aggregation for any transport network, including SDH/SONET, IP/MPLS, MPLS-TP, CE and OTN/DWDM
- Point-to-point and point-to-multipoint radio system supports up to 750 Mbps over sub-6 GHz bands, with dedicated bandwidth allocation per site and service reach of up to 120 km (74.5 miles)
- Complies with environmental standards for outdoor installation in harsh conditions



**Megaplex-4**  
Next-Generation Multiservice Networking Node



**Ceragon/Airmux**  
Wireless Transport Platform



**DXC-5**  
High Capacity Hybrid Cross Connect



**PowerFlow**  
Managed Ruggedized Ethernet Switch with Power over Ethernet



**PacketLight-1000/2000**  
Complete Solutions for WDM/OTN and Dark Fiber Applications



**RADview**  
Management and Domain Orchestration

# Oil and Gas Utility Communications

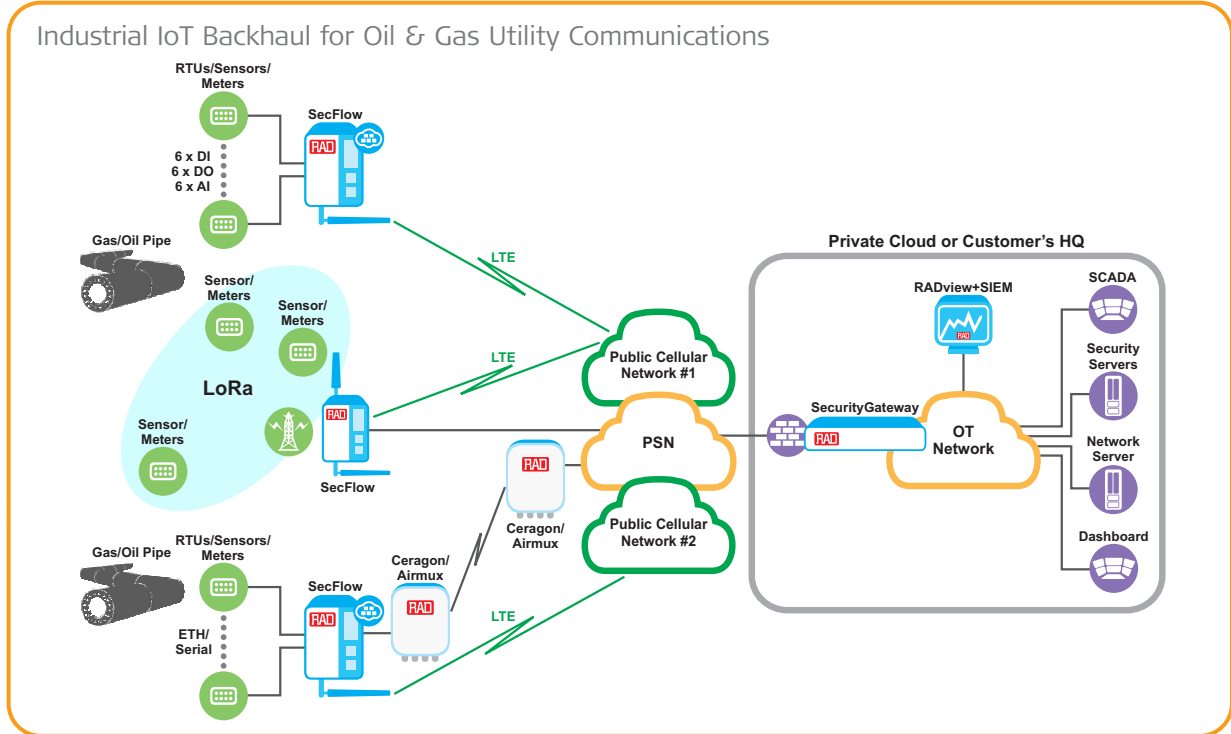

## Your Benefits:

- A comprehensive and secure solution addressing communications for compressor stations, LACT and flow meters, etc.
- Integrated IEC 61131-3 RTU/PLC
- Integrated LoRaWAN gateway
- Virtual environment for user-tailored applications allows customers to add new applications on top of SecFlow devices
- Zero-touch provisioning, enhanced cyber security (IPsec, PKI, FW, IDS/IPS, SIEM)
- Seamless communications over fiber optics, radio links, 2G/3G/LTE/5G cellular links, and leased lines from a telecom service provider
- Secure remote access for end-user device management
- Transparent delivery of SCADA, protocol conversion and terminal server
- Complies with Class I div 2
- Point-to-multipoint radio connectivity supports high capacity mission-critical traffic over licensed and unlicensed sub-6 GHz bands



**SecFlow**  
Industrial IoT Gateway with Programmable Logic Controller



**SecurityGateway**  
VPN Aggregator, Router and Firewall



**Ceragon/Airmux**  
Wireless Transport Platform



**RADview**  
Management and Domain Orchestration



# Highway Communications

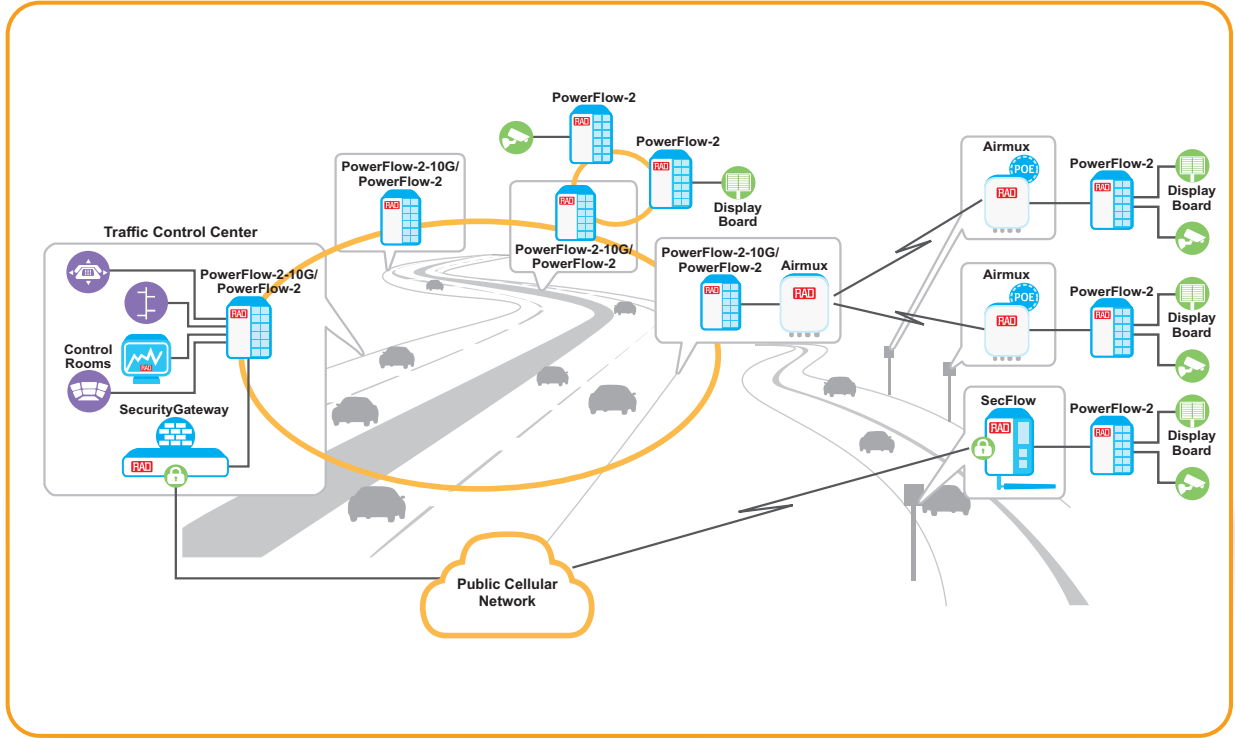

## Your Benefits:

- Backhaul high-definition video feeds, roadside display board and billing station data from remote facilities over fiber, high throughput microwave PTP and PtMP radio links, and 10-GbE rings
- Enable outdoor installations with industrial design and ruggedized enclosures
- Extensive PoE support including PoE++ and Airmux PoE
- 10-GbE carrier-grade Ethernet core rings with traffic management capabilities ensure reliable connectivity with appropriate quality of service for various applications
- 5G support where fiber isn't available



**PowerFlow**  
Managed Ruggedized Ethernet Switch with Power over Ethernet



**SecFlow**  
Ruggedized SCADA-Aware Ethernet Switch/Router



**Ceragon/Airmux**  
Wireless Transport Platform



**RADview**  
Management and Domain Orchestration



# Train and Metro Communications

## 1 Operational WAN for Trains and Metros

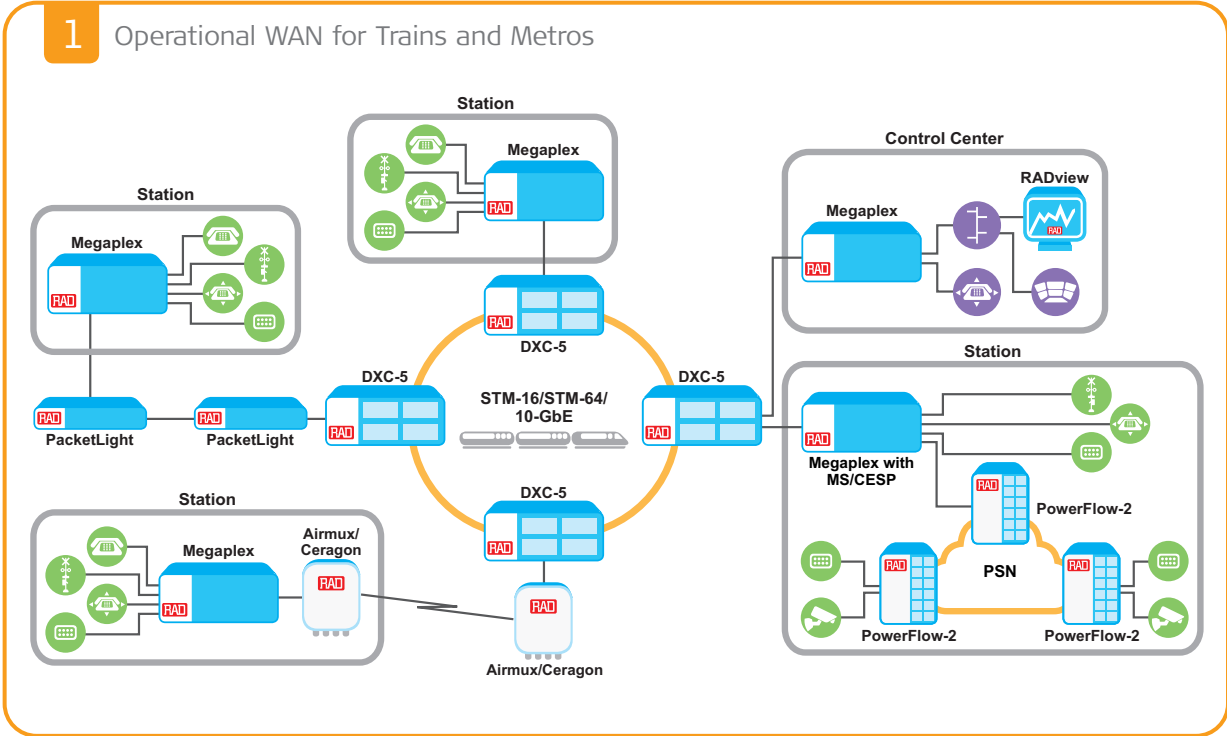

### Your Benefits:

- Ensure protected connectivity between stations and control room using multidrop and ring topologies
- Ethernet extension over fiber or copper (SHDSL) to enable service reach to remote M2M and video devices
- Support mission-critical railway applications, including automatic train supervision (ATS), centralized traffic control (CTC), SCADA, and multiparty hotlines, as well as passenger information systems (PISs)
- Support legacy TDM and Ethernet traffic delivery over SDH/SONET/IP/MPLS/MPLS-TP/CE/DWDM/OTN and/or carrier-grade fiber optic rings
- Supports analog and digital data and voice devices, as well as Ethernet IEDs, with versatile rates from RS-232 up to STM-64/OC-192 or 10-GbE
- Point-to-point and point-to-multipoint radio connectivity supports high capacity mission-critical traffic over licensed and unlicensed bands



**Megalex**  
Next-Generation Multiservice Networking Node



**DXC-5**  
High Capacity Hybrid Cross Connect



**PL-1000/PL-2000**  
Complete Solutions for WDM/OTN and Dark Fiber Applications



**Ceragon/Airmux**  
Wireless Transport Platform



**PowerFlow**  
Managed Ruggedized Ethernet Switch with Power over Ethernet



**RADview**  
Management and Domain Orchestration



## 2 Industrial IoT Backhaul for Trains and Metros

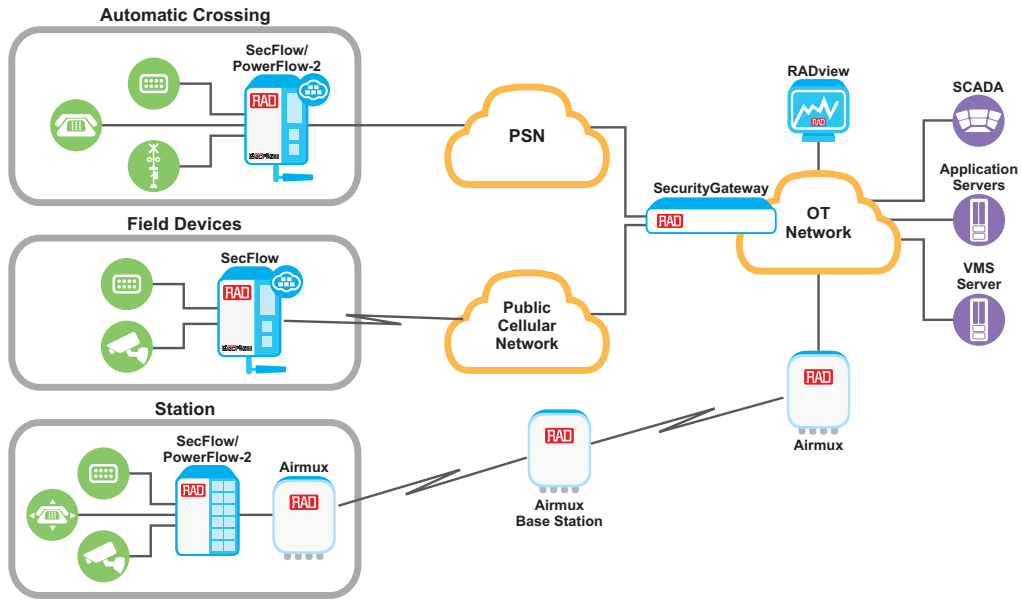

### Your Benefits:

- A comprehensive and secure solution addressing communications along railway tracks, wayside signaling, interlocking, and safety systems
- Integrated IEC 61131-3 RTU/PLC
- Virtual environment for user-tailored applications allows customers to add new applications on top of SecFlow devices
- Zero-touch provisioning, enhanced cyber security (IPsec, PKI, FW, IDS/IPS, SIEM)
- Seamless communications over fiber optics, radio links, 2G/3G/LTE/5G cellular links, and leased lines from a telecom service provider
- Secure remote access for end-user device management
- Transparent delivery of SCADA, protocol conversion and terminal server
- Complies with EN 50121-4
- Point-to-multipoint radio connectivity supports high capacity mission-critical traffic over licensed and unlicensed sub-6 GHz bands



**SecFlow**  
Industrial IoT Gateway with Edge Computing



**SecurityGateway**  
VPN Aggregator, Router and Firewall



**Ceragon/Airmux**  
Wireless Transport Platform



**RADview**  
Management and Domain Orchestration



# Air-Traffic Control Communications

## 1 Industrial IoT Backhaul for Remote Unmanned Sites

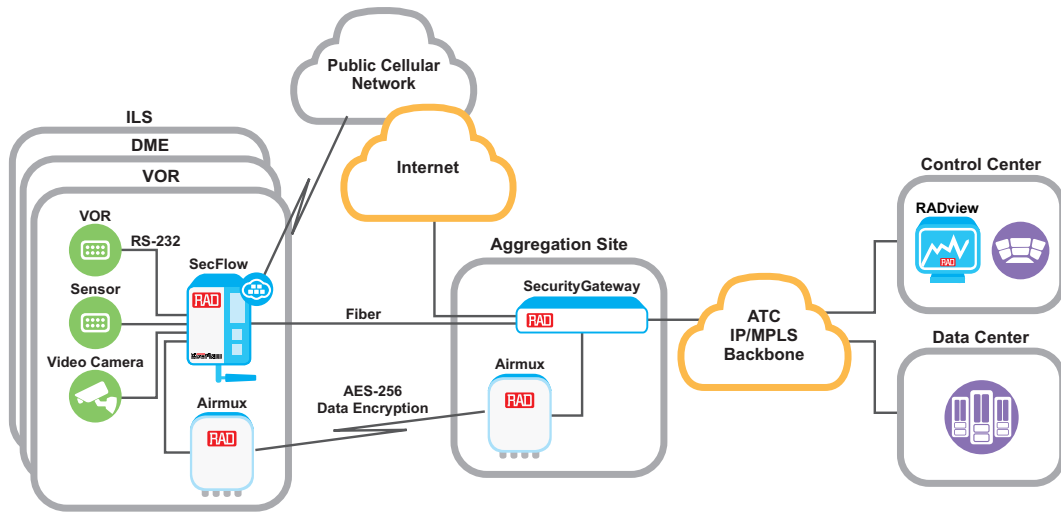

### Your Benefits:

- Ensure management and monitoring for unmanned ATC sites (VOR, DME, ILS)
- Integrated IEC 61131-3 RTU/PLC
- SCADA capabilities, dry contacts and serial tunneling
- Extensive PoE support for CCTV camera applications
- Zero-touch provisioning, enhanced cyber security (stateful firewall, SCADA, IPS/IDS, SIEM)
- Seamless communications over fiber optics, radio links, 2G/3G/LTE/5G cellular links and leased lines
- Integrated IPsec encryption with automated PKI support
- Transport traffic over copper, fiber, microwave, or satellite links
- Point-to-point and point-to-multipoint radio connectivity for high capacity mission-critical traffic over licensed and unlicensed bands
- Secure remote access for end-user device management



**SecFlow**  
Industrial IoT Gateway with Edge Computing



**SecurityGateway**  
VPN Aggregator, Router and Firewall



**Ceragon/Airmux**  
Wireless Transport Platform



**RADview**  
Management and Domain Orchestration





## 2 Multiservice Operational WAN for Air-Traffic Control

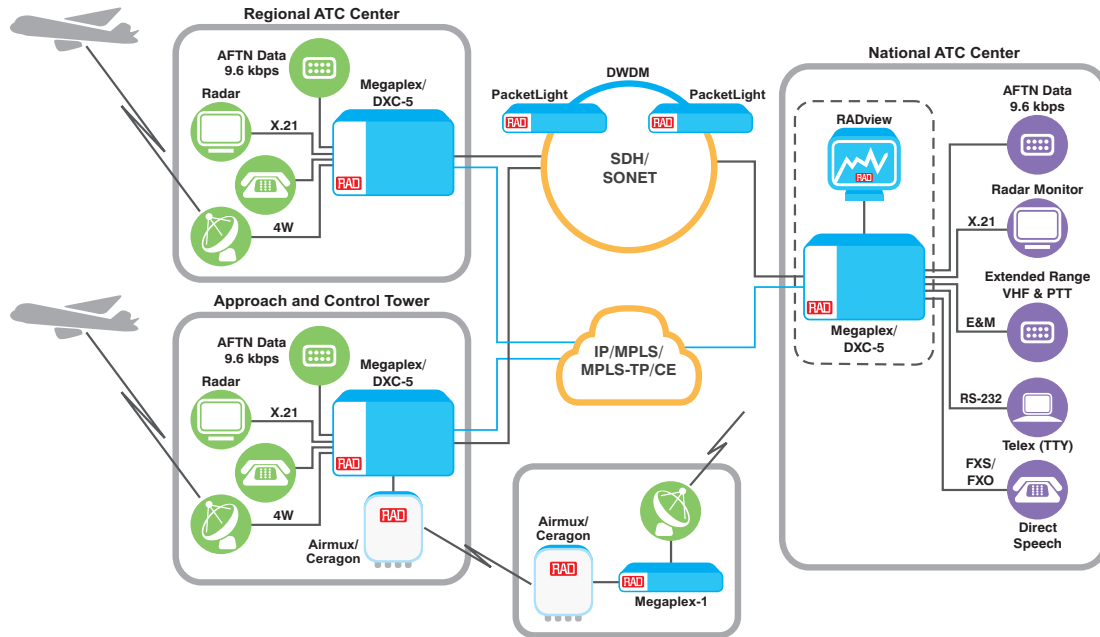

### Your Benefits:

- Ensure reliable, uninterrupted communications between different traffic control centers with RAD's multiservice connectivity solutions over any transport network, including SDH/SONET, IP/MPLS, MPLS-TP, CE, OTN, DWDM
- Deliver direct speech (DS), Telex (TTY), radar data (RD), extended range VHF (ER), and VHF data link (VDL) traffic, together with other voice, fax and LAN services, using industry-standard interfaces
- Transport traffic over copper, fiber, microwave, or satellite links
- Distributed SCADA security suite with integrated firewall and encryption
- Optimized for subrate leased line transmission and backup to reduce OpEx
- Ruggedized platforms withstand the rigors of field operations
- Support fail-safe operations with ISDN, VSAT and Ethernet backup



**Megaplex**  
Next-Generation Multiservice  
Networking Node



**DXC-5**  
High Capacity Hybrid  
Cross Connect



**Ceragon/Airmux**  
Wireless Transport  
Platform



**PL-1000/PL-2000/PL-4000**  
Complete Solutions for WDM/OTN  
and Dark Fiber Applications



**RADview**  
Management and  
Domain Orchestration

# Smart City Communications

## 1 Industrial IoT Backhaul for Smart Cities

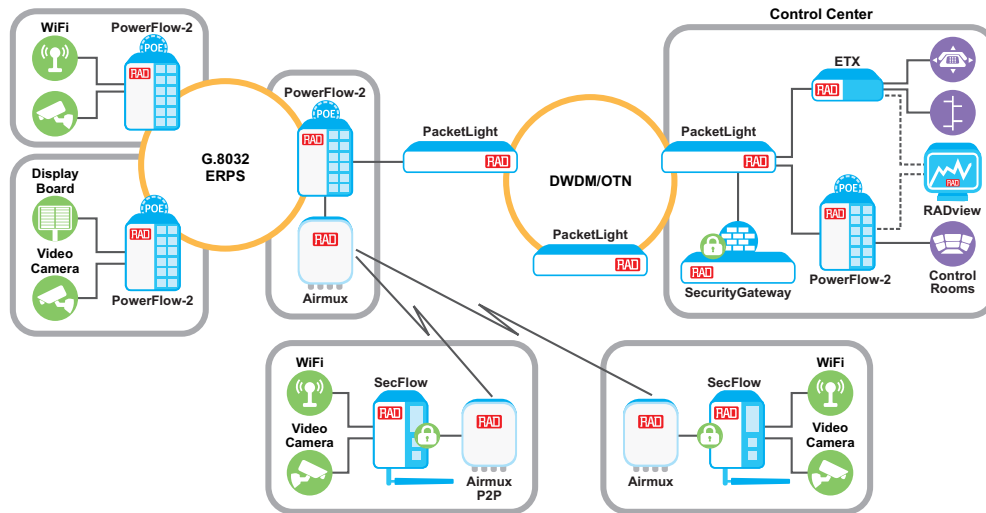

### Your Benefits:

- A comprehensive communications solution for CCTV cameras, WiFi access points, sensors, payment kiosks, etc.
- Integrated LoRaWAN gateway
- Ruggedized devices for outdoor installations
- Virtual environment for user-tailored applications allows customers to add new applications on top of SecFlow devices
- Seamless communications over fiber optics, radio links, 2G/3G/LTE/5G cellular links, and leased lines
- Zero-touch provisioning with enhanced cyber security (integrated IPsec, encryption, stateful firewall, SIEM)
- Secure remote access for end-user device management
- Transparent delivery of legacy traffic from serial-based devices
- Local video recording
- Point-to-multipoint radio connectivity supports high capacity mission-critical traffic over licensed and unlicensed sub-6 GHz bands



**SecFlow-1v, SecFlow-1p**  
Industrial IoT Gateway with Edge Computing



**PowerFlow**  
Managed Ruggedized Ethernet Switch with Power over Ethernet



**Ceragon/Airmux**  
Wireless Transport Platform



**RADview**  
Management and Domain Orchestration



## 2 Operational WAN for Smart Cities

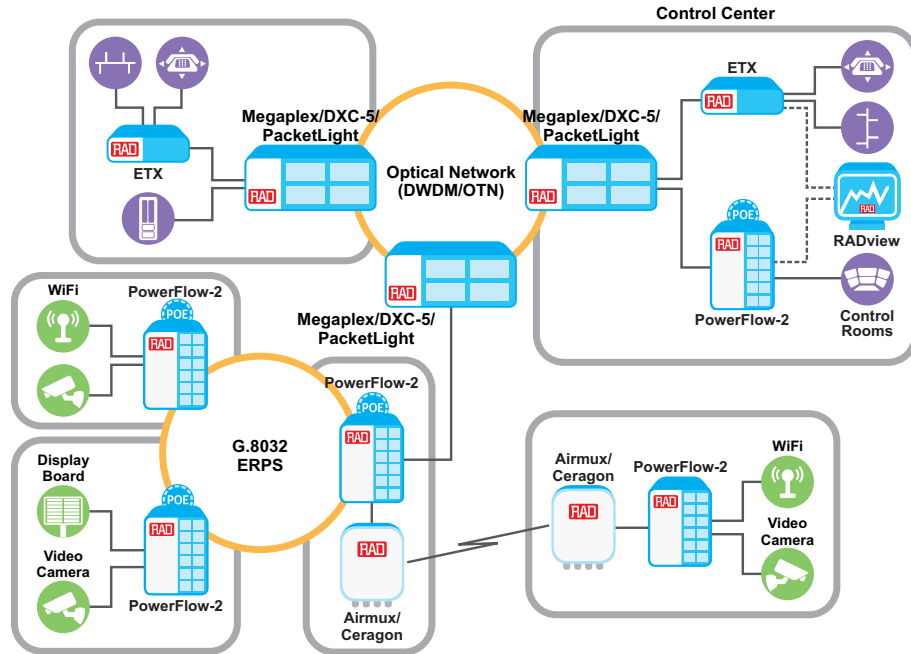

### Your Benefits:

- Provides a comprehensive solution for all Smart City communications
- Connect security cameras, WiFi access points, display boards, meter concentrators, and other sensors in urban and rural areas over fiber optics and wireless radios
- Central management to provision and control the communications network
- Long-distance fiber optic private network backbone with OTN/DWDM multi-tunneling at rates of up to 100G
- Secure connectivity over public/private networks
- Turnkey deployment solutions by RAD for Safe City, including communications, video surveillance and analytics systems, cameras, and sensors
- G.8032 Ethernet Ring Protection Switching (ERPS) and PoE support



**Megaplex**  
Next-Generation Multiservice Networking Node



**DXC-5**  
High Capacity Hybrid Cross Connect



**PowerFlow**  
Managed Ruggedized Ethernet Switch with Power over Ethernet



**Ceragon/Airmux**  
Wireless Transport Platform



**PL-1000/PL-2000/PL-4000**  
Complete Solutions for WDM/OTN and Dark Fiber Applications



**RADview**  
Management and Domain Orchestration

# First Responders and Military Communications

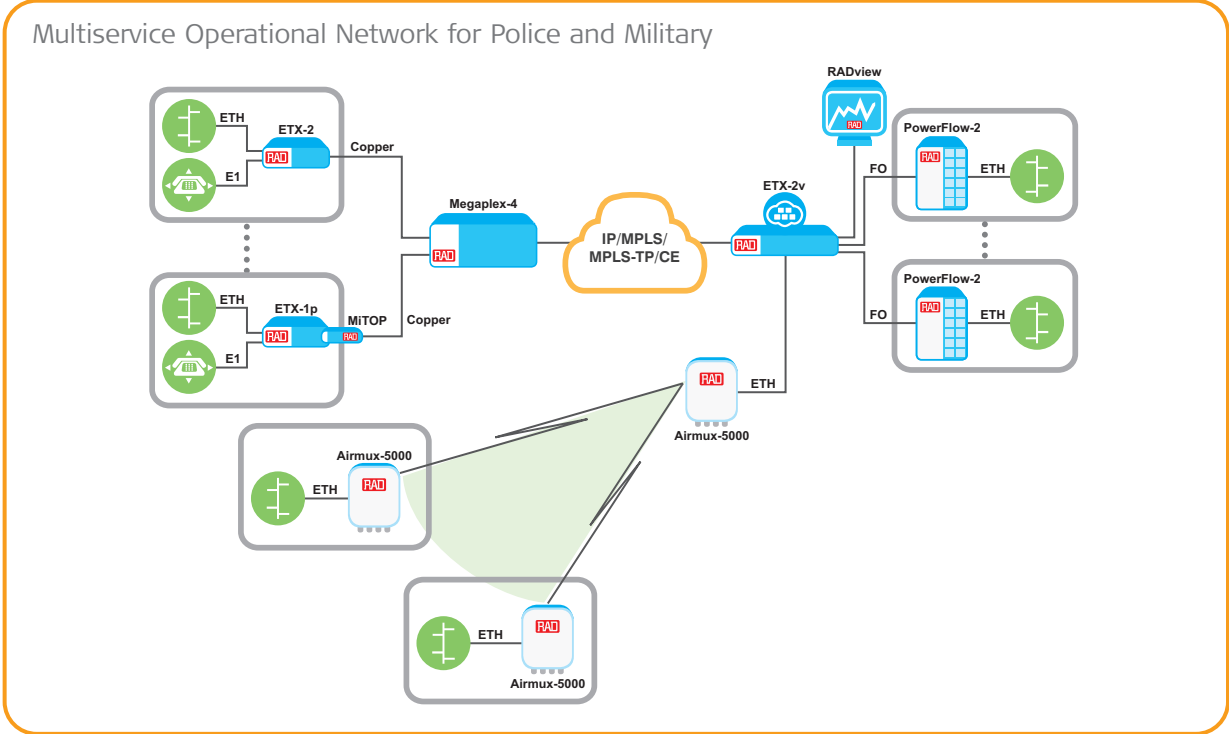

## Your Benefits:

- Connect a privately owned government/military/public network to remote sites using diverse infrastructure
- Support multiple services, including Ethernet, TDM and low speed data, using the same device
- Utilize existing SDH/SONET network or build a state-of-the-art IP/MPLS, MPLS-TP, CE backbone
- Secure remote access for end-user device management



**Airmux-5000**  
Point-to-Multipoint Broadband Wireless Access



**PowerFlow**  
Managed Ruggedized Ethernet Switch with Power over Ethernet



**ETX-2/ETX-2i**  
Carrier Ethernet Demarcation



**ETX-2/ETX-2i**  
Carrier Ethernet Demarcation - Outdoor Units



**RADview**  
Management and Domain Orchestration

# RAD Products



## Airmux-400

### Point-to-Point Broadband Wireless Access



RAD's Airmux-400 series of point-to-point broadband wireless radios delivers native Ethernet and TDM services over a single wireless link in various sub-6 GHz frequencies. The high capacity Airmux-400 radio systems provide aggregated throughput of up to 750 Mbps and a range of up to 120 km (75 miles).

The Airmux-400 incorporates advanced features, such as MIMO and OFDM for optimal performance and unmatched robustness in all environments, making it ideal for:

- Utilities AMI/DA backhaul
- Public safety and government backhaul
- Transportation (highways and railways backhaul)

- **Multi-band operations over 2.4 GHz, 3.5 GHz, and 4.9 to 6 GHz in a single device**
- **5 MHz, 10 MHz, 20 MHz, 40 MHz, or 80 MHz channel bandwidth**
- **TDM over packet integration for TDM service support with other RAD TDMoIP products**
- **Net throughput (aggregated):**
  - Airmux-400H: up to 750 Mbps
  - Airmux-400P: up to 250 Mbps
  - Airmux-400A: up to 500 Mbps
  - Airmux-400SP: up to 25 Mbps
- **OFDM, MIMO and antenna diversity capabilities**
- **Extended range – up to 120 km (75 miles)**
- **Hub-site synchronization (HSS) supports simultaneous transmission from up to 16 colocated Airmux-400 and/or Airmux-5000 units**
- **Ring protection link (RPL) for Ethernet resiliency**
- **Spectral power measurement and RF survey tool – “Spectrum View” – for quick and easy installation**

## Airmux-5000i/ Airmux-5000D

### Point-to-Multipoint Broadband Wireless Access



RAD's Airmux-5000 point-to-multipoint broadband wireless radios are the ideal wireless solution for business users demanding high capacity throughput with dedicated traffic bandwidth allocation and service level agreement (SLA) per subscriber. Featuring up to 750 Mbps aggregated sector capacity and a range of up to 40 km (25 miles), a single Airmux-5000i base station supports up to 64 remote subscriber units (SUs) with multi-band operation, making it ideal for:

- Service providers and ISPs, offering IP backhaul and 4G/broadband access for remote, rural and underserved communities
- Private networks requiring high capacity inter-branch connectivity for university campuses, healthcare organizations, government institutions, large enterprises, and public establishments
- Security and surveillance applications requiring aggregation and backhaul of traffic from multiple colocated HD cameras
- **Airmux-5000/5000i/5000D multi-band operations over 2.4 GHz, 3.3 – 3.8 GHz and 4.9 – 6.4 GHz in a single device**
- **Airmux-5000D includes two radios (3.x GHz and 5.x GHz) in a single unit**
- **Up to 750 Mbps aggregated throughput per sector/band**
- **Up to 64 remote subscriber units per sector with aggregated throughput of 5, 10, 20, 25, 50, and 100 Mbps**
- **Supports fixed and nomadic applications**
- **Airmux-5000i with beamforming antenna**
- **5 MHz, 10 MHz, 20 MHz, or 40 MHz channel bandwidth**
- **OFDM, MIMO and antenna diversity capabilities**
- **Range up to 40 km (25 miles)**
- **Intra- and inter-site TDD synchronization using hub-site synchronization (HSS) and GPS**
- **Low constant latency – typically 4 to 10 msec in full sector load**

## • A/B

## ASMi-54 Family SHDSL.bis Modems

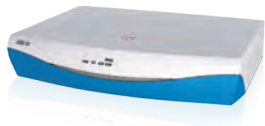

The ASMi-54 line includes the multi-port ASMi-54 advanced SHDSL.bis modem and the cost-effective ASMi-54L SHDSL.bis modem. The devices support point-to-point and hub-and-spoke connectivity as well as drop-and-insert (daisy chain) and ring topologies over copper and fiber.

The managed SHDSL.bis modems extend E1 and mid-band Ethernet services over multipair-bonded copper links. Ensuring reliable performance over poor quality or noisy lines, the devices employ next-generation SHDSL technology and EFM bonding to achieve variable data rates of up to 22.8 Mbps. The ASMi-54 family is ideal for service providers, mobile operators, enterprises, utilities, and transportation companies. The devices feature a compact, half 19-inch enclosure, with optional rail-mountable metal enclosure for deployment in extreme temperature environments.

- Up to four Fast Ethernet ports with an integrated switch; optional one (ASMi-54L) or four (ASMi-54) E1 interfaces
- ITU-T G.991.2, ETSI 101524; TC-PAM 16 or TC-PAM 32
- ASMi-54: up to 22.8 Mbps over 8-wire (4 pairs)
- ASMi-54L: up to 11.4 Mbps over 4-wire (2 pairs), 5.7 Mbps over 2-wire (1 pair), or up to 30 Mbps over 4-wire using RAD's high performance SHDSL technology
- EFM bonding per IEEE 802.3-2005; M-Pair bonding for HDLC
- VLAN prioritization, rate limitation per port and Ethernet QoS support; Ethernet OAM per IEEE 802.3-2005 (formerly 802.3ah)
- Managed via SNMP, Telnet and ASCII terminal

## BiDi QSFP Adaptor 100G/400G Dual to Single Fiber Adaptor



RAD's patented BiDi miniature passive adaptor fits any transceiver with LC connectors to perform a simple dual to single bi-directional fiber connectivity. This 100G/200G/400G QSFP adaptor doubles fiber capacity while avoiding costly new fiber/transceiver deployments. A simple to deploy bookend solution, it is ideal for network service providers, cloud providers, data center operators, and enterprise network operators wishing to better utilize their existing fiber. BiDi QSFP Adaptor allows them to simply pair a small form-factor passive adaptor with any fiber QSFP transceiver. This reduces the need for costly fiber trenching and frees up fiber for other services.

- 50% fiber savings with quick ROI
- Works at any bit rate: 40G, 100G, 200G, 400G
- Unique patented technology complements QSFP28, QSFP-DD, QSFP+, CFP-2
- Compact and simple to deploy (no need for configuration or additional power source)
- Low insertion loss (<2 db including connectors)
- 1300-nm (1291-1312) wavelength at any supported bandwidth rate
- Operates over various optical distances: 10 km, 20 km, 40 km and 80 km
- Double fiber capacity while avoiding costly new fiber/transceiver deployments



## Ceragon FibeAir IP-20

### Wireless Transport Platform



**CERAGON**

Ceragon's wireless transport platform accommodates various needs in different scenarios while maintaining availability and security at the highest standards.

The FibeAir IP-20 platform meets any critical infrastructure wireless transport need, of any scale, in any topology and at any frequency, combined with an advanced security feature set and low-latency performance.

The FibeAir IP-20 comes in all-outdoor, split-mount and all-indoor configurations supporting 6.86 GHz frequency range.

#### FibeAir IP-20C:

- Double wireless backhaul capacity via remote activation of another radio carrier with no site visits required
- Provides the highest radio capacity and spectral efficiency in any condition and any frequency channel size (up to 80/112 MHz)
- Field-proven 4x4 LoS MIMO technology – enabling 1-Gbps radio capacity over a single 30-MHz channel or 2 Gbps over a single 60 MHz

#### FibeAir IP-20E:

- Provides ultra-high radio capacity and spectral efficiency of up to 2.5 Gbps over a 500-MHz channel
- Minimizes your sites' physical footprint with an integrated flat panel antenna

#### FibeAir IP-20S:

- Compact, all-outdoor wireless backhaul node that is optimized for simple installation and operation
- Operates within the entire microwave spectrum (6 – 42 GHz)

## Ceragon IP-50

### Disaggregated Wireless Transport Platform



Ceragon's IP-50 series resolves modern wireless transport challenges via disaggregation that is implemented in three independent innovation paths: Radio, networking hardware and networking software.

- IP-50E: 20 Gbps/link universal E-Band radio
  - Radio capacity: 20 Gbps (2+0 XPIC configuration, utilizing two units)
  - Simple upgrade – utilize existing link in conjunction with the IP-50E with Layer 1 carrier bonding
- IP-50C: Universal quad-carrier microwave solution – up to 8 Gbps
  - Save tower load and shelter space with 4+0 configuration in all-outdoor
  - The capacity you need, in any range, with 224-MHz channel support – up to 8 Gbps
  - 4x4 LoS MIMO
  - Advanced frequency reuse
  - Advanced space diversity

- IP-50S: Universal microwave radio
  - Simple upgrade – utilize existing link in conjunction with the IP-50S with Layer 1 carrier bonding
- IP-50FX: Disaggregated wireless hauling router
  - White box, merchant-silicon based hardware, with Ceragon Radio Aware Open Networking software for zero-compromise open-platform migration



## • D/E

### DXC-5, DXC-5P High Capacity Hybrid Cross Connect

Hot Product



RAD's DXC-5 enables a seamless migration to next-generation operational networks. It provides multiservice, high capacity core and edge aggregation over TDM, hybrid and all-packet transport. The DXC-5 reduces operational costs by using a single platform for all service requirements. Critical infrastructure network operators choose the DXC-5 as it coexists with legacy cross connects, then seamlessly replaces them when they reach end-of-life status, allowing the addition of new services and bandwidth capacity. DXC-5's transport flexibility ensures that services are matched to the best technology to meet their requirements. By performing multiplexing over packet, DS1-level TDM switching and DWDM in the same device, it reduces the transport cost per bit and ensures mission-critical reliability with minimal latency.

- High density MPLS-TP/Carrier Ethernet/SDH/SONET platform available in 1U-, 2U- and 5U-high form factors
- High capacity: From E1/T1 to STM-64/OC-192, 10 GbE with a variety of connectivity options including MPLS-TP, Carrier Ethernet, PDH, SDH/SONET, OTN, DWDM, and 1G-10G
- Non-blocking SDH/SONET switch capabilities
- TDM circuit emulation
- MPLS-TP with traffic-engineered pseudowire
- Carrier Ethernet 2.0-certified including Ethernet OAM, QoS
- Sub-50 ms protection: 1:1, 1+1, APS, BLSR, PW, ERPS, LAG
- Synchronization: BITS, Sync-E, ACR

### ETX-2i IP and Carrier Ethernet Demarcation with D-NFV

Hot Product

Part of RAD's Service Assured Access solutions, the ETX-2i line of next-generation NID/NTUs offers advanced demarcation for SLA-based, L2 and L3 business services, wholesale services and mobile backhaul. The ETX-2i offers a complete service life-cycle toolset, as per MEF 3.0 specifications.

The ETX-2i also serves as a universal CPE (uCPE) Whitebox+, which enhances a pluggable x86 server module with physical network functions (PNFs) to enable superior performance for vCPE applications. It is supported by RADview management and orchestration.



• E

• **ETX-2i: IP and Carrier Ethernet Demarcation Device with D-NFV**



Available as a modular demarcation device, the ETX-2i enables operators to deliver the most advanced Carrier Ethernet services, IP VPNs and vCPE functionalities over any network connection. In addition, the ETX-2i combines advanced timing functionalities for LTE/LTE-A.

- Up to eight GbE combo ports
- Integrated wire-speed switch/router
- Modular network interfaces: FE/GbE (combo), E1/T1, T3, VDSL2, or SHDSL
- Flexible synchronization offering Sync-E, IEEE 1588v2 slave, BC and TC for frequency and phase synchronization in mobile networks
- Hot-pluggable x86 D-NFV server module for hosting virtual functions
- NEBS-compliant and environmentally hardened enclosure options
- 3U device with six GbE combo ports and 64 x E1/T1, offering high scale, cost-effective TDM over packet services

Hot Product

• **ETX-2i-B: IP and Carrier Ethernet Demarcation Device with D-NFV for SMBs**



ETX-2i-B is a demarcation device optimized for remote branches and SMBs over native Ethernet access. It is ideal for carriers, service providers, and wholesale operators requiring advanced Ethernet L2/L3 functionality at customer premises and multi-tenant units (MTUs).

- 1U device with up to ten GbE ports
- Fan-less 2U device with ten GbE ports, ideal for cost-effective small-cell aggregation
- Integrated 6-Gbps switch/router
- Pluggable x86 D-NFV server module for hosting virtual functions (1U device)

• **ETX-2i-10G: 10G Carrier Ethernet Demarcation/Aggregation Device**



The ETX-2i-10G combines intelligent, high bandwidth demarcation and aggregation capabilities for enterprise headquarters and mobile backhaul operators. As an aggregation solution at the concentration point, a single unit can support numerous services and concurrent OAM sessions.

- 19" unit with up to four 10-GbE and up to 24 GbE ports in various combinations
- Half and full 19" unit with up to eight 10-GbE ports or four 10-GbE and up to eight GbE ports in various combinations
- Flexible synchronization offering Sync-E, IEEE 1588v2 slave, BC and TC for frequency and phase synchronization in mobile networks
- ITU-T G.8032 Ethernet Ring Protection Switching
- NEBS-compliant and environmentally hardened enclosure options



• E >>>

• **ETX-2i-100G: 100-GbE Carrier Ethernet Demarcation Device**

Hot Product



ETX-2i-100G delivers the full suite of Carrier Ethernet demarcation and aggregation capabilities, at 100-GbE rates. MEF 3.0-certified, the ETX-2i-100G addresses the increasing demand for high bandwidth access to data centers, while maintaining SLA guarantees, service monitoring, flexibility, and management.

- **19", 1U device with redundant power supply**
- **Two 100G platforms:**
  - Three 100-GbE (QSFP28) and 10 x 1/10-GbE SFP+ interfaces
  - Four 100-GbE (QSFP28) and 16 x 1/10-GbE SFP+ interfaces
- **Advanced QoS with hierarchical policing and bandwidth shaping per EVC and EVC.CoS**
- **Accurate and scalable hardware-based OAM and performance monitoring per ITU-T Y.1731 and TWAMP**
- **Y.1564 service activation testing of up to 100G at wire speed**

**ETX-2**  
Carrier Ethernet Demarcation

Hot Product

The ETX-2 line of Carrier Ethernet NID/NTUs offers demarcation for SLA-based business services, wholesale services and mobile backhaul. The ETX-2 is MEF Carrier Ethernet 2.0-certified for E-Line, E-LAN, E-Tree, and E-Access services, as well as delivering TDM pseudowire over packet networks. Supporting high capacity service provisioning per EVC/EVC.CoS, flexible classification and H-QoS traffic management, it also performs accurate and scalable service testing and performance monitoring. The ETX-2 is supported by RADview management and enables a variety of protection mechanisms. It also offers NEBS-compliant and environmentally hardened enclosure options.



• **ETX-203AX: Carrier Ethernet Demarcation Device**



ETX-203AX is ideal for carriers, service providers, and wholesale operators requiring advanced Ethernet functionality at customer premises and multi-tenant units (MTUs).

- Four and six FE/GbE ports; flexible selection of SFP and copper interfaces
- Optional SHDSL network port for cost-effective Ethernet over SHDSL service
- Optional E1/T1 PDH user port to be encapsulated and transported over Ethernet
- Wide-range AC/DC power supply

• **ETX-203AX-T: Carrier Ethernet Device with LTE/Broadband Connectivity**



ETX-203AX-T extends Ethernet VPN services to new, out-of-reach locations, allowing rapid site commissioning by using readily available LTE or broadband networks. The ETX-203AX-T enables cost-effective Ethernet VPN services backup using LTE or broadband. Additional cost optimization can be achieved by splitting traffic between a service-assured VPN and best-effort LTE or broadband access.

- Five FE/GbE ports with flexible selection of SFP and copper interfaces
- Full suite of MEF CE-2.0 capabilities for SLA monitoring, diagnostics and fault detection
- Optional built-in LTE modem with global service coverage
- Data and management protection using LTE or broadband
- Secure EVC tunneling over private IP/LTE networks or over the internet using L2oGRE or L2TPv3 protocols
- Integrated wide-range AC/DC power supply
- Fragmentation and IPsec support

• **ETX-203AM: Universal Carrier Ethernet Demarcation Device**



Available as a modular demarcation device, the ETX-203AM enables operators to deliver Carrier Ethernet services and L2 VPNs over any network connection.

- Four FE/GbE user ports
- Modular network interfaces: FE/GbE (combo), E1/T1, T3, VDSL, or SHDSL

• **ETX-205A Carrier Ethernet/Mobile Demarcation Device**



The ETX-205A provides advanced Carrier Ethernet demarcation and offers combo interfaces and power supply redundancy. For LTE/LTE-A mobile backhaul, the ETX-205A is installed at cellular tower and controller sites to guarantee differentiated SLAs.

- L2 VPN service demarcation with superior traffic management and monitoring capabilities
- Distributed Grandmaster architecture integrating built-in GPS receiver with IEEE 1588v2 Grandmaster functionality for cost-optimized LTE deployments
- Flexible synchronization offering Sync-E, IEEE 1588v2 slave, BC and TC for frequency and phase synchronization in mobile networks
- E1/T1 pseudowire services per MEF-8, UDP/IP, MPLS static labeling in SAToP and CESoP modes, and with CAS

A

B

C

D

E •

F

G

H

I

J

K

L

M

N

O

P

Q

R

S

T

U

V

W

X

Y

Z

• E

**ETX-1p**  
Physical CPE for Branch  
Routing and Edge Access  
to Cloud

Hot Product



ETX-1p is an economical thin CPE enabling business customers' transition to the cloud. As a disaggregated CPE, it hosts virtualized function containers. By combining powerful networking capabilities with flexible connectivity options, rich management interfaces and embedded security functions, the ETX-1p enables service providers to deliver advanced IP-VPN services, as well as value-added virtual services from the data center to the customer branch. The all-in-one device includes an embedded router and a next-generation firewall, together with switching capabilities and LTE and WiFi support, making it easy to connect branches to private and public clouds over mobile or fixed broadband or over MPLS, without the need for extra hardware or complicated configurations.

ETX-1p is bundled with vCPE-OS, RAD's carrier-grade, Linux-based operating system. Designed to run on various ARM- and x86-based CPE platforms, vCPE-OS is security hardened and optimized to provide maximum performance at a low footprint.

- vCPE-OS operating system
- Hosting of third-party software using Linux LXD container technology
- Multiservice support: GbE copper and fiber
- Single or dual cellular modem for a 2G/3G/HSPA+/HSDPA/LTE uplink; dual SIM for always-on connectivity
- WiFi access point
- Dynamic routing with OSPF, BGP, VRF and secure VPN using IPsec, DMVPN and NAT for flexible connectivity
- Cyber security suite: 802.1X, IPsec encryption with automated PKI, stateful firewall
- Zero-touch provisioning, firewall configuration, fault management and reporting, bulk software upgrade, and database management using RADview

**ETX-2v**  
Open vCPE White Box  
Platform

Hot Product



The ETX-2v includes a line of carrier-grade white boxes installed at the customer premises – either at headquarters or in remote branch sites. The ETX-2v products support a wide range of business customers and user scenarios, from small offices to large sites, using a variety of bandwidth, processing power and LAN/WAN options.

- White box appliances for virtual CPE, SD-WAN and NFV featuring powerful x86 processors
- Hardware-based security featuring a Trusted Platform Module (TPM)
- Flexible SFP/UTP connectivity with optional interfaces including: LTE, WiFi, VDSL, GPON, ETHoPDH, PWE, and more
- Supports a range of x86 CPU technologies (Rangeley, Denverton and Xeon D), with flexible multi-core options
- Various memory (RAM, SSD) size options
- Intel QuickAssist technology – authentication, encryption, etc.
- SR-IOV capable ports to enhance throughput
- Fan-less, low power (~7W) options reduce carbon footprint
- Rack-mount and desktop options

## ETS-1

### Ethernet Access Switches



The ETS-1 line of next-generation Ethernet access switches provides 1G/10G end-user connectivity to large-scale corporate networks, small and medium businesses and service providers. Offering a rich set of L2 and L3 features and highly effective cost-performance ratio, they are ideal for upgrading old infrastructure and for Smart City communications.

- **Stacking support**
- **Multicast support: IGMP snooping, MVR**
- **Advanced security: Multilayer ACLs, IP Source Guard, and Dynamic ARP Inspection**
- **High port density, up to 48 10G ports (ETS-1-10G)**
- **PoE/PoE+ support (ETS-1-10G)**
- **Ethernet OAM, QoS and rate limiting**

## ETX-5

### Ethernet Service Aggregation Platform



The ETX-5 is a leading CE-2.0 access aggregation switch, successfully deployed worldwide in many large networks. It delivers aggregated Ethernet and TDM pseudowire traffic from the access network to the PE (provider edge) over 10-GbE links. Part of RAD's Service Assured solutions for service providers and critical infrastructure, the ETX-5 is ideal for first-level aggregation at the POP, E-NNI inter-carrier demarcation and as a pseudowire gateway for seamless migration to packet networks.

For an enhanced user experience, the ETX-5 is supported by the RADview management and orchestration system, featuring an intuitive UI/UX to simplify configuration and enable zero-touch service provisioning end-to-end. The ETX-5 is Carrier Ethernet 2.0-certified and includes an extensive toolset to deliver and manage SLA-based services.

- **MEF Carrier Ethernet 2.0-certified: E-Line, E-LAN, E-Tree services, E-Access; MEF-8; MEF-22: Mobile backhaul; MEF-26: E-NNI**
- **Ethernet Ring Protection Switching: ITU-T G.8032v2; supports 40-GbE ring over LAG, virtual rings**
- **Extensive TDM pseudowire support: CESoPSN, SAToP, CESoETH (MEF-8), UDP/IP encapsulation**
- **Ethernet OAM termination and grooming; ITU-T Y.1564 generator/responder**
- **16 x 10-GbE network/user ports; 80 x 1-GbE ports; 16 channelized STM-1/OC-3 user/network ports; four channelized STM-4/OC-12 user/network ports with redundancy**
- **Fully redundant, modular system designed for high availability**
- **Supported by RADview Service Manager and RADview Performance Monitoring portal**
- **AC or DC power feed redundancy; NEBS-compliant industrial-grade enclosure withstands extended temperature range**



A

B

C

D

E •

F

G

H

I

J

K

L

M

N

O

P

Q

R

S

T

U

V

W

X

Y

Z

## • I/L

## IPmux-2L

### TDM Pseudowire Access Gateway



The IPmux-2L is a cost-effective TDM pseudowire access gateway, extending TDM, HDLC and LAN traffic over dark fiber, IP, MPLS, or Ethernet. The device provides an ideal solution for circuit emulation and legacy leased line services, as well as for PBX backhaul, PSTN access, TDM trunking over packet transport, and cellular backhaul. Incorporating a multi-standard pseudowire ASIC, it enables transparent delivery of legacy user traffic over next-generation transport with minimal processing delay.

IPmux-2L supports point-to-point and hub-and-spoke network topologies, offering a complete migration solution when combined with other TDM pseudowire CPEs and aggregation gateways supporting TDM pseudowire (such as ETX-5 and Megaplex-4).

- Up to two E1 user ports
- Optional n x 64 serial user data port
- Multi-standard TDM pseudowire ASIC: TDMoIP, CESoPSN, SAToP, CESoETH, HDLCoPSN
- QoS support with four priority queues
- Pseudowire OAM
- High precision clock recovery for 2G/3G cellular traffic over PSN; optional Sync-E support
- Centralized SNMP-based remote management with RADview

## LA-210

### EFM DSL Network Termination Unit



The LA-210 enables service providers to deliver mid-band Ethernet and high speed Ethernet where fiber is not present, by offering Ethernet access rates of up to 22 Mbps over bonded SHDSL.bis copper lines based on standard EFM (Ethernet in the First Mile) technology. Installed at the customer premises, it delivers Ethernet services, such as inter-office LAN connectivity, internet access and virtual private networks (VPNs), as well as legacy TDM service, using pseudowire emulation. The LA-210 features Carrier Ethernet attributes, including Ethernet OAM for proactive SLA monitoring, quality of service (QoS) per Ethernet flow and advanced traffic management capabilities – all starting at the service hand-off points. The LA-210 is certified by the Metro Ethernet Forum to deliver Ethernet Private Line (EPL) and Ethernet Virtual Private Line (EVPL) services per MEF-9 and MEF-14 specifications.

- Mid-band Ethernet access up to 22 Mbps using EFM bonding
- Up to four pairs of EFM bonded SHDSL.bis uplink lines
- Up to four Fast Ethernet user ports
- Pseudowire support for E1, V.35 or X.21 traffic
- MEF CE 2.0-certified
- Advanced QoS mechanism per EVC/EVC.CoS
- Ethernet link and service OAM with performance monitoring for end-to-end SLA control
- Multi-standard pseudowire support for legacy services over PSN



## Megaplex-1

Multiservice Pseudowire  
Access Gateway

Hot Product



RAD's Megaplex-1 is a compact, highly reliable multiservice access node that transports analog and TDM traffic originating from legacy circuit-switched devices over packet switched networks (PSNs). It is specifically designed to address the needs of critical infrastructure network operators who are migrating to next-generation Ethernet, IP or MPLS communications. This includes utilities, transportation operators and government agencies. It enables seamless service migration with a scalable TDM over packet pseudowire engine and comprehensive multiservice support for PDH, high and low speed data, analog voice, and Teleprotection devices.

- Grooming and transmitting analog voice and TDM-based services over packet using standard pseudowire technology
- Wide range of services: E1/T1, FXO/FXS/E&M, IEEE C37.94, programmable serial ports and more
- PWE redundancy per tunnel for ultra-fast hitless restoration ensures maximum service uptime
- Bridge functionality with two optical/copper GbE uplinks and up to four FE user interface ports
- 1U 19-inch fan-less enclosure with redundant, wide-range power supply (AC/DC)

## Megaplex-4

Next-Generation  
Multiservice Access  
Node

Hot Product



RAD's Megaplex-4 is a carrier-class, high capacity multiservice access concentrator for delivering legacy and next-generation services over PDH/SDH/SONET and packet switched transport networks (PSN). Its ability to handle a broad range of Ethernet, data and voice services, as well as a large variety of network technologies, in a single compact managed node, makes it an ideal aggregation solution for carriers and service providers.

The device also provides a perfect fit for large enterprises, utilities and transportation companies who require an efficient way to transport and provision multiple legacy and next-generation services over their high capacity pipes. Megaplex-4 can be used as a central aggregation unit for CPEs carrying TDM and Ethernet services over various access link technologies, e.g., SHDSL and SDH/SONET.

The Megaplex-4 is available with a cable management solution to reduce storage space and handling, and eliminate cable waste.

- Modular 4U or 2U 19-inch units housing multiple I/O modules
- Carrier-class reliability with hardware, service and system redundancy
- Hardened and certified for IEEE 1613, including fan-less operation for power utilities and EN 50121-4 for railways
- Integrated MPLS switch and IP router
- MEF Carrier Ethernet 2.0-certified with traffic management, performance monitoring and Ethernet OAM
- Hybrid Ethernet and TDM architecture supporting various services up to STM-4/OC-12 and multi-GbE
- Three-tier built-in cyber security, including 802.1x and MACsec
- Non-blocking cross connect for a high volume of DS0 channels
- Built-in support for distance and differential Teleprotection for power utility applications
- Integral xDSL copper modems and fiber multiplexer cards
- Voice compression, terminal server, serial multiplexer and OMNibus voice conferencing modules
- Pluggable x86 D-NFV server module for hosting virtual functions and applications
- Interoperability with existing TDM equipment (Nokia, Newbridge)

A

B

C

D

E

F

G

H

I

J

K

L

M •

N

O

P

Q

R

S

T

U

V

W

X

Y

Z



• M

**MiCLK**  
1588 Grandmaster on an SFP with Built-In GNSS



RAD's MiCLK® is the world's first Grandmaster on an SFP, allowing easy upgrades for existing base stations and backhaul equipment to support IEEE 1588 for LTE/LTE-A. Easily plugged into service routers to simultaneously distribute frequency and time, the patented MiCLK eliminates the need to install GPS/GNSS antennas at every cell site while providing highly accurate timing distribution with full network coverage – even in underground and in-building installations. It is also ideal for 4G small-cell deployments.

The field-proven MiCLK allows service providers to avoid spoofing and jamming risks, and dramatically reduces installation and engineering costs by eliminating the need for additional space or power requirements.

- Fully-featured standard IEEE 1588 Grandmaster including phase/Time of Day (ToD) to meet stringent LTE-Advanced requirements
- Built-in GNSS receiver
- Robust GNSS backup – time holdover when GNSS reception is lost, using Sync-E or 1588 frequency reference from the network (Assisted Partial Timing Support) to deliver continuous and accurate synchronization to the base station
- Miniature pluggable device fits in any standard SFP port
- Scalable solution supports up to 64 slaves
- Part of RAD's vCPE offering

**MiNID**  
Miniature Programmable Network Interface Device

Hot Product



MiNID® is a field-programmable miniature L2/L3 network interface device (NID), available in a variety of form factors. Part of RAD's vCPE and white box solution portfolio, it enriches the Service Assured Access offering with software-defined functionalities for enhanced demarcation, remote monitoring and fault isolation, as well as remote packet capture and micro-burst measurement capabilities.

MiNID also provides instant upgrades for legacy switches and routers, as well as for vCPE platforms and COTS servers to help service providers, mobile operators and wholesale carriers introduce new services quickly and with better quality of experience (QoE) while increasing operational efficiency and lowering costs. Remotely managed via CLI, web interface and SNMP, it features zero-touch provisioning for fast and simple installation and does not require dedicated training.

• MiNID SFP



The MiNID SFP is easily pluggable into SFP ports of switches and routers and eliminates the need for standalone demarcation devices. It delivers substantial OpEx savings by eliminating additional power, space and cabling expenses.

- Plug-and-play installation
- Fits small cells, macro cells, switches, routers, DSLAMs, COTS servers and more
- Variety of optical options
- LC connectors
- Extended temperature range



#### • MiNID Sleeve



The MiNID Sleeve is easily pluggable into SFP ports of switches and routers and seamlessly hosts standard FE and GbE SFP modules.

- **Compatible with standard fiber and copper SFPs in a variety of ranges**
- **Reduces inventory by reusing existing SFPs**

#### • MiNID Standalone



The MiNID is also available in a miniature standalone enclosure, with a variety of user and network port options for maximum interface flexibility. Optional bypass-relay functionality ensures fail-safe operation and Power over Ethernet (PoE) support eliminates the need for an additional power supply.

- **Two ports with flexible user or network functionalities**
- **Combo ports automatically select between fiber and copper/RJ-45**
- **Internal bypass relay for copper interfaces offers service continuity in the event of power failure**
- **Bypass PoE enables powering both the MiNID and the end device**

### MiRiCi-E1/T1, MiRiCi-E3/T3, MiRiCi-ML/E1,T1

Smart SFP Ethernet to E1/T1 or E3/T3 Remote Bridges



RAD's MiRiCi-E1/T1, MiRiCi-E3/T3 and MiRiCi-ML/E1,T1 connect Fast Ethernet or Gigabit Ethernet LANs over framed or unframed E1 or T1 circuits, or over framed T3 links. The smart SFP miniature remote bridges provide TDM connectivity to any Ethernet device with an SFP (small form-factor pluggable) compatible Fast Ethernet or GbE port. Hot-swappable and software-configurable, the intelligent SFPs are fully managed devices supporting standard GFP encapsulation, as well as HDLC and cHDLC. MiRiCi-ML supports PPP and ML-PPP. They deliver a complete Ethernet over PDH solution in finger-sized SFP enclosures and enable a quick rollout of new Ethernet services over legacy TDM infrastructure. The MiRiCi-E1/T1, MiRiCi-E3/T3 and MiRiCi-ML are part of RAD's vCPE Toolbox. They provide simple and cost-effective alternatives to external, standalone bridge units or conversion cards for user devices, saving on space, cabling and power consumption, and simplifying management.

- **Supports framed and unframed E1/T1, E3/T3**
- **Supports standard GFP, HDLC-like, and cHDLC encapsulation**
- **Supports PPP and ML-PPP**
- **Hot-insertion SFP-format plug, MSA-compliant**
- **User-configurable**
- **Enhanced management of control, status and monitoring**
- **Out-of-band management through I<sup>2</sup>C**
- **Supports full duplex flow control**
- **Fault propagation from WAN to LAN link**
- **Software download via TFTP**
- **Supports Ethernet OAM per 802.3-2005 (formerly 802.3ah)**
- **Part of RAD's vCPE offering**

A

B

C

D

E

F

G

H

I

J

K

L

M •

N

O

P

Q

R

S

T

U

V

W

X

Y

Z

• M/O

**MiTOP-E1/T1,  
MiTOP-E3/T3**  
Smart SFP-Format TDM  
Pseudowire Gateways



RAD's MiTOP-E1/T1 and MiTOP-E3/T3 transport framed or unframed E1/T1 or E3/T3 traffic, respectively, over Ethernet, IP and MPLS networks. Featuring multi-standard pseudowire support and Synchronous Ethernet (Sync-E) in a finger-sized enclosure, the smart SFP devices provide an ideal solution for service providers, utility companies and enterprises wishing to ensure highly accurate timing synchronization for their legacy services while migrating to packet switched transport.

Part of RAD's "System on an SFP" portfolio, the MiTOP-E1/T1 and MiTOP-E3/T3 are designed for quick and simple insertion into any Fast Ethernet or Gigabit Ethernet port with an MSA-compatible socket.

- Transmits TDM-based services over Ethernet, IP or MPLS networks
- Standard pseudowire encapsulation: CESoPSN, SAToP
- Single E1/T1 or E3/T3 TDM user port
- Transparent to all signaling protocols
- Hot-insertion SFP-format plug, MSA-compliant
- Selectable clock source
- Basic management of control, status and monitoring
- Supports Synchronous Ethernet (Sync-E)
- Part of RAD's vCPE offering
- Supports fractional E1/T1
- Supports CESoPSN CAS
- Up to eight pseudowire tunnels per E1/T1

**Optical Bypass Switch**  
Fiber Protection Switching  
System



The Optical Bypass Switch is capable of automatically bypassing faulty network nodes in the event of a power outage. It is used in optical fiber communications and fits ring or linear fiber network architectures. Featuring AC or DC power supply, the Optical Bypass Switch automatically identifies the power supply status at the network node and helps avoid network outages caused by node failures.

- Small in size
- Easy installation and operation
- Low insertion loss – minimum impact on existing optical budget
- Non-latching type – automatic recovery
- LED indicators for power and optical switch status

- A
- B
- C
- D
- E
- F
- G
- H
- I
- J
- K
- L
- M
- N
- O
- P
- Q
- R
- S
- T
- U
- V
- W
- X
- Y
- Z



## Optimux-106, Optimux-108

Fiber Multiplexers for 4 E1/T1  
and Ethernet or Serial Data



The Optimux-106 and Optimux-108 fiber multiplexers deliver TDM and Fast Ethernet or serial data traffic over a fiber optic link, providing a simple, low-cost solution for point-to-point and point-to-multipoint connectivity up to 120 km (75 miles).

- Up to four E1 or T1 ports and a Fast Ethernet user interface; optional V.35 user port
- Full 100 Mbps Ethernet data rate (user)
- Simple plug-and-play installation
- Range extension up to 120 km (75 miles)
- Redundant uplink interfaces and power supplies
- Card versions for the Megaplex-4
- Management via ASCII terminal, web server, Telnet or RADview
- Temperature-hardened enclosures
- Dedicated 10/100BaseT Ethernet management port

## Optimux-1025

Fiber Multiplexer for 16 T1 and  
Gigabit Ethernet



The Optimux-1025 provides a cost-effective solution for transparently delivering Gigabit Ethernet traffic, as well as multiple T1 links, over a fiber optic link for distances up to 120 km (75 miles). The single-box solution for fiber TDM and Ethernet connectivity offers CapEx and OpEx savings with "pay-as-you-grow" flexibility by supporting initial deployments at partial capacity, with license-based upgrades when needed. The plug-and-play functionality allows carriers, service providers, mobile operators, and large organizations to extend their service reach at lower costs.

- Up to 16 T1 ports; up to three Gigabit Ethernet user ports
- Total fiber uplink capacity of 1,000 Mbps
- Simple plug-and-play installation
- Range extension up to 120 km (75 miles)
- Redundant hot-swappable uplink interfaces and power supplies
- Management via RADview, CLI, ASCII terminal, SNMPv3
- RADIUS, SSH
- Temperature-hardened enclosure

A

B

C

D

E

F

G

H

I

J

K

L

M

N

O •

P

Q

R

S

T

U

V

W

X

Y

Z

## • P

**PacketLight**

Complete Solutions for WDM/OTN and Dark Fiber Applications Layer 1 Encryption



PacketLight's product suite offers the flexibility to build a cost-effective, highly efficient optical network infrastructure for CWDM/DWDM, OTN and dark fiber connectivity, while addressing challenges faced by service providers and organizations.

PacketLight solutions are ideal for a variety of vertical markets, such as carriers, ISPs, dark fiber providers, data centers, storage facilities, utility companies (railway and power companies), and financial institutions.

The wide range of PacketLight xWDM and dark fiber solutions includes multi-rate sub-10G CWDM/DWDM platforms, 10G CWDM/DWDM and 100G solutions with built-in OTN options, amplification and booster solutions, WSS-based ROADMs, ten 1-GbE muxponders, and passive multiplexing solutions.

- Multi-rate transponders, 2 Mbps to 200 Gbps
- Muxponder for high wavelength utilization; scales to 96 wavelengths
- Layer-1 encryption for GbE, 10-GbE, 4G FC, 8G FC, and 16G FC
- Long-distance solutions by amplification and DCM
- Performance monitoring
- Supports single or dual fiber
- Low latency connectivity
- Hot-swappable PSU (AC/DC) and fan
- Integrated management
- Compact 1U integrated devices, multi-chassis scalability
- Simple to install, maintain and configure
- Cost-effective CPE device
- Integrated OTN layer (with FEC)

**PM Controller**

Performance Monitoring Generator



The PM Controller is a high capacity, central generator for always-on performance monitoring (PM), on-demand testing, diagnostics and troubleshooting of mobile backhaul networks, as well as for premium Carrier Ethernet and IP business services. It uses a wide variety of standard tools to provide deep visibility into network and service performance and to ensure optimal quality of experience in LTE/LTE-A networks, typically characterized by rapid small-cell deployment. Part of RAD's Service Assured Access offering, the PM Controller works opposite routers, switches, mobile base stations, or third-party responders, as well as opposite RAD's ETX and MiNID NIDs. As a non-disruptive add-on, the PM Controller is an ideal solution for existing heterogeneous networks. It enables top-line PM and testing in a dynamic environment regardless of the capabilities of the underlying installed base.

- Four FE/GbE combo ports
- Monitors and troubleshoots backhaul performance
- Service activation tests (Y.1564) over L2/L3, opposite RAD devices or third-party responders
- Continuous connectivity and service performance monitoring sessions using TWAMP, ICMP and UDP Echo
- Connects to the RADview Performance Monitoring portal for SLA and quality of experience (VoLTE mean opinion score) reporting with aggregated and drill-down views per PM session

## PowerFlow

Managed Ruggedized Ethernet Switches with Power over Ethernet

Hot Product

RAD's PowerFlow consists of managed and unmanaged industrial-grade Gigabit Ethernet switches, designed to build packet-based, PoE-intensive operational networks for critical infrastructure.

PowerFlow is ideal for OT WANs of power utilities, railways, traffic controllers, and Safe City applications requiring advanced Ethernet functionality and Power over Ethernet (PoE) support.

- **PowerFlow-2:  
Managed Ruggedized Ethernet Switches with Multiple Options**



RAD's PowerFlow-2 is a series of industrial-grade, managed Fast Ethernet and Gigabit Ethernet switches, with or without PoE support, which provide stable and reliable Ethernet transmission. Housed in ruggedized DIN rail or wall-mountable enclosures, these switches are specifically designed for harsh environments, such as industrial networking and intelligent transportation systems (ITS), as well as military and utility market applications where environmental conditions exceed commercial product specifications.

- Compact Ethernet switches with up to 16 x 10/100/1000BaseT ports, and eight x 100/1000BaseFX SFP ports
- Variety of input voltage from 12–48V DC to HVDC of 110/220V DC and support of 110/220V AC
- Variety of PoE feeding options including PoE (802.3af), PoE+ (802.3at) and PoE++ (60W)
- Flexible deployment scenarios using xSTP, ERPS (ITU-T G.8032) and ultra-fast recovery with PF-Ring/chain
- Certified for EN 50121-4, IEC 61850-3, IEEE 1613 and NEMA TS2
- Wide range of operating temperatures from -40°C to 75°C (-40°F to 167°F)

- **PowerFlow-2-10G:  
Industrial 10G Core Switch Demarcation/Aggregation Device**



RAD's PowerFlow-2-10G managed industrial-grade core switches provide a wide variety of reliable mechanisms for mission-critical network communications. These mechanisms include redundant and isolated power supplies, STP/RSTP/MSTP and ITU-T G.8032 Ethernet Ring Protection Switching. The PowerFlow-2-10G is a fan-less unit with IP30 ruggedized metal housing to meet demands of industrial-grade and core layer applications.

- Industrial-grade Ethernet switches equipped with four 10G SFP+ ports
- Variety of input voltage and PoE feeding options including PoE+ with up to 400W per unit
- 19" unit with up to four 10-GbE and up to 24 GbE ports in various combinations
- Supports STP, RSTP, MSTP, ITU-T G.8032v1, G.8032v2 Ethernet Ring Protection Switching (ERPS), and PF-Ring for redundant cabling
- Environmentally hardened enclosure options

A

B

C

D

E

F

G

H

I

J

K

L

M

N

O

P •

Q

R

S

T

U

V

W

X

Y

Z

## • R

## RADinsight PM

LAN to Cloud  
Performance Monitoring

Hot Product



RADinsight PM subscription-based services offer meaningful insights to service providers and their L2 business customers.

RADinsight PM turns user traffic samples and KPIs, collected from RAD EADs, into contextual user and service data. It offers simple access to historical data and operational recommendations.

RADinsight PM replaces long, service affecting troubleshooting procedures and saves on call center costs, truck rolls and unnecessary CPE replacements.

- **RADinsight PM dashboard, presenting at-a-glance views of network segments: Customer LANs, service provider's WAN and internet/cloud**
- **Per customer and per segment network KPIs at a given time-frame, including round-trip-time, jitter and packet loss**
- **Per customer and per segment quality scores, calculated based on customer's KPI trends**
- **Per destination URL views**
- **Access to customer's historical data**

## RADview

Network Management  
and Orchestration

RADview is a modular network management and edge domain orchestration suite for RAD's Service Assured Access and Service Assured Networking solutions. It enables configuration, provisioning, monitoring, and management of networks and services, and includes the following management tools:

- Network element manager
- Performance monitoring portal for ongoing monitoring of Ethernet and IP services
- D-NFV orchestrator for virtual machines and application services at the customer edge
- End-to-end service manager for planning and activation of Carrier Ethernet services
- Service center for managing TDM services

RADview is fully compliant with the ITU-T Telecommunications Management Network (TMN) standards, and features advanced fault, configuration, administration, performance, security (FCAPS) capabilities. Using an SNMP southbound interface, it also includes third-party device monitoring capabilities. RADview's northbound interface enables integration into a third-party umbrella system (OSS).

RADview's security information and event management (SIEM) enables collection of all security events detected in the network. The system collects cyber security events from all RAD gateway devices in the network and displays them visually on customizable dashboards, with configurable dynamic updates and a searchable database.

- **Monitors device health, optimizes network operations and minimizes mean time to repair (MTTR)**
- **Client/server architecture with multi-user support and seamless handover of user privileges**
- **Zero-touch and auto-discovery capabilities**
- **Wide range of northbound application programming interfaces (APIs)**
- **Firewall configurator for remote clusters and devices**
- **Syslog server with optional manual message filtering**
- **Interoperable with third-party NMS and leading OSS/umbrella systems**
- **Multi-platform Java-based solution supporting Windows and Linux**
- **IBM Tivoli's Netcool®/OMNIBUS™**

Intuitive, HTML5 UI/UX:

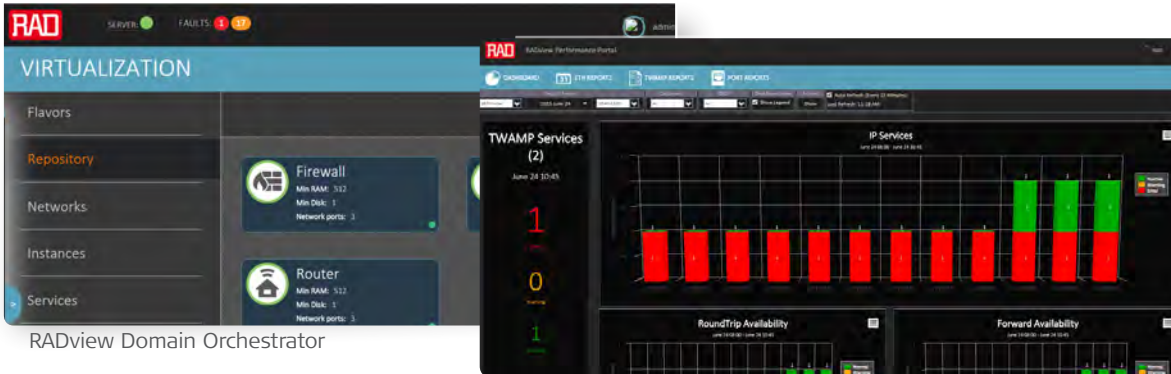

RADview Domain Orchestrator

RADview Performance Monitoring

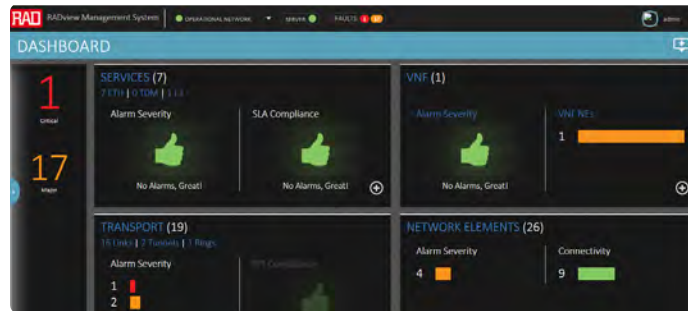

RADview Service Manager

• RADview Performance Monitoring



The RADview Performance Monitoring module enables ongoing monitoring of Ethernet and IP service performance by collecting KPI (key performance indicator) data from RAD devices. Part of RAD’s Service Assured solutions, it allows service providers and network operators to easily monitor and manage actual network and service performance over time and compare it to service requirements and SLA (service level agreement) guarantees.

The RADview Performance Monitoring module enables immediate detection of service degradation, so that remedial actions are taken to quickly restore guaranteed performance levels. The system retrieves data lost due to connection failures and exports standard CSV ASCII files to OSS or third-party management systems.

- Collects, stores, analyzes and presents KPIs from RAD devices
- In-service bandwidth utilization measurements
- Actual performance metrics based on ITU-T Y.1731:
  - Frame delay (latency)
  - Frame delay variation (jitter)
  - Packet delivery ratio
  - Availability
- TWAMP-based L3 performance monitoring for IP services
- SLA threshold policy management
- Performance dashboard with aggregated and drill-down views
- Monthly and real-time SLA statistics reporting



A  
B  
C  
D  
E  
F  
G  
H  
I  
J  
K  
L  
M  
N  
O  
P  
Q  
R  
S  
T  
U  
V  
W  
X  
Y  
Z



## • R

• **RADview Domain Orchestrator**

The RADview Domain Orchestrator manages the physical and virtual resources required for effectively running vCPE services and for delivering service agility at the customer edge.

The Domain Orchestrator installs, configures and manages RAD's vCPE portfolio, as well as any x86 white box running the vCPE-OS.

In addition, it manages the VNF life-cycle from onboarding new VNFs to configuring services, chaining VNFs, deploying service function chains and ongoing monitoring of live services.

Featuring a web client with state-of-the-art user interface (UI), the RADview Domain Orchestrator enables fast and easy service creation and management of value-added applications and provides a holistic view of the vCPE services.

- **NFVI management (VIM)**
- **VNF and network service onboarding**
- **Service function chain design and deployment using point-and-click UI**
- **Service maintenance (SFC backup, resource adjustment)**
- **Ongoing fault management and performance monitoring**

• **RADview Service Manager**

The RADview Service Manager module is part of the RADview management suite and provides end-to-end management of MEF-based Carrier Ethernet services for Service Assured Access. An intuitive GUI, point-and-click functionality and easy-to-follow wizards facilitate planning, provisioning, monitoring, diagnostics, and SLA assurance, so that network operators can add new service offerings, as well as minimize overall operating costs, reduce provisioning times and maximize the efficiency of the entire network.

- **Offline resource optimization and capacity planning simplifies pre-deployment stages**
- **Point-and-click end-to-end service provisioning and OAM settings**
- **Automatic correlation of network faults with impacted services and customers**
- **Security management supporting user access profiles and allowing network partitioning**
- **Graphic representation of network clouds, links, nodes, end-to-end services, and network status indication**
- **Standard northbound interfaces to third-party OSS systems**
- **GUI designed for management of very large networks**



### • RADview Service Center

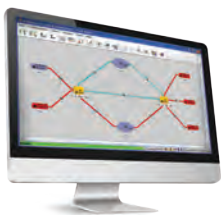

The RADview Service Center path management system enables end-to-end management of RAD's TDM access products, while easy-to-follow wizards facilitate provisioning and monitoring over SDH/SONET and PDH networks. Supported capabilities include automatic path routing, automatic re-routing of protected paths, physical and logical representation of the network links, and more. The system allows network operators to add new service offerings while minimizing overall operating costs, reducing provisioning times and maximizing the efficiency of the entire network.

- Point-and-click provisioning from a central workstation for networks of RAD products
- Automatic periodic self-healing of faulty services
- Service security management, supporting user network access profiles and allowing network partitioning
- Service availability report
- Dynamic filter displays service and network link-related alarms
- Windows-based client and Linux-based server

## RADWIN Fiber In Motion

Mobile Wireless Access for Transportation Communications



# RADWIN

RADWIN's mobile wireless radios for transportation communications ensure continuous high speed wireless connectivity between trains or metros and network control and data centers. They deliver the highest throughput for on-board communications with guaranteed bandwidth to each railway vehicle, even on subways and monorail lines. RADWIN's radios offer bi-directional and asymmetrical train-to-track bandwidth with per-train quality of service (QoS) guarantees. This allows always-on communications between trains and control and operations centers for critical services such as information displays, panic buttons, PTT (push-to-talk), telemetry, ticketing machines, and video streaming. They are fully compliant with railway environmental standards, which are a prerequisite for all equipment installed on railways and metros. RADWIN's field-proven mobile wireless access devices are deployed worldwide, powering applications such as broadband WiFi for passengers, real-time high-definition CCTV, PIS, CBTC and more. Operating in challenging outdoor conditions and in underground tunnels, they deliver unmatched capacity and long-range coverage.

- Coverage range of 11 km (6.8 miles)
- Integrated WiFi access point (802.11b/g/n) for video transmissions
- Built-in GPS for vehicle tracking
- Direct DC power from the vehicle (10–36V DC), power consumption <25W
- Up to 750 Mbps total available throughput from the base station
- Up to 250 Mbps total available throughput for vehicle/vessel subscriber units
- SNMPv3
- AES 128
- IP67 rating for severe outdoor conditions

## • R

## RIC-LC

### Ethernet Converter for Multiple PDH Circuits



RAD's RIC-LC is a Fast Ethernet over E1 converter that provides simple, efficient and cost-effective Ethernet connectivity over up to 16 bonded E1 links. As an Ethernet converter for multiple PDH circuits, the RIC-LC enables service providers to supply high capacity Ethernet services to remote locations over existing TDM infrastructure. Deployed in point-to-point or hub-and-spoke topologies, it operates opposite Ethernet over TDM demarcation devices and aggregators, such as RAD's RICi-16 as well as opposite third-party gateways that support Ethernet over NG-PDH encapsulation and bonding techniques.

The RIC-LC is an ideal solution for Ethernet Private Line and Ethernet Private LAN services, inter-office connectivity, and IP DSLAM, IP Node B and WiMAX base station backhaul over PDH access networks.

- Up to 16 E1 network interfaces
- Four Fast Ethernet UTP/SFP user ports
- GFP (G.8040), VCAT (G.7043), LCAS (G.7042)
- VLAN-aware and VLAN-unaware bridging; VLAN stacking
- Four QoS levels; SP and WFQ scheduling; CIR (committed information rate) support
- Remote and local, inband and out-of-band management
- Dual in-line package (DIP) switches for activating diagnostic loopback tests
- TDM to Ethernet fault propagation

## RICi-4E1, RICi-4T1, RICi-8E1, RICi-8T1

### Ethernet over Four or Eight E1 or T1 NTUs



RAD's RICi-4E1, RICi-4T1, RICi-8E1 and RICi-8T1 deliver mid-band and Fast Ethernet services over up to eight bonded E1 or T1 circuits. Employing various standard bonding technologies to create a scalable, virtual channel from individual E1 or T1 circuits, these devices improve overall network availability by reducing latency and optimizing line utilization and throughput. RAD's RICi NTUs support a large variety of applications, including transparent inter-LAN connectivity, direct internet access and Ethernet Private Line, as well as IP DSLAM and WiMAX base station backhaul.

The devices are deployed in point-to-point or hub-and-spoke topologies, providing a cost-effective, high performance solution for mid-band and Fast Ethernet services over legacy PDH/SDH/SONET backbones.

- Four or eight E1/T1 ports
- Up to four 10/100BaseT user ports
- Circuit bonding using MLPPP
- Metro Ethernet Forum certified for MEF-9 EPL services
- Four QoS levels according to VLAN priority (802.1p), DSCP, and per-port priority schemes, per application requirements
- Ethernet OAM per 802.1ag and performance monitoring per ITU Y.1731 for end-to-end SLA control
- Secure Telnet and web applications; SNMP and RADIUS



## RICi-16

Ethernet over Bonded PDH NTU



The RICi-16 connects Fast Ethernet LANs over multiple bonded PDH links, enabling service providers to extend high capacity Ethernet-based services to remote locations. It is also ideal for backhauling Ethernet traffic from IP Node Bs, IP DSLAMs and WIMAX base stations over copper-based or microwave PDH connections. Employing standard Ethernet over NG-PDH technology, the RICi-16 improves overall network availability by reducing latency and optimizing line utilization and throughput.

The RICi-16 is MEF-certified for Ethernet Private Line and Ethernet Virtual Private Line services. It is equipped with advanced Ethernet SLA capabilities for handling multi-priority traffic, ensuring latency, jitter and packet delivery performance on a per-flow basis. The RICi-16 features a “pay-as-you-grow” license model, allowing the addition of E1/T1 links according to evolving bandwidth requirements.

- Up to 16 E1/T1 ports; two bonded clear channel T3 ports or a single channelized T3 port
- Up to four 10/100BaseT user ports
- Circuit bonding using standard GFP, VCAT and LCAS with multi-VCG support
- Metro Ethernet Forum certified (MEF-9, MEF-14) for EPL, EVPL services
- Hierarchical QoS with configurable Strict Priority and WFQ (weighted fair queuing) scheduling, EVC shaping
- Color-sensitive P-bit re-marking
- Ethernet OAM per 802.3-2005 (formerly 802.3ah), 802.1ag and performance monitoring per ITU Y.1731 for end-to-end SLA control
- Secure Telnet and web applications; SNMPv3 and RADIUS

## RICi-E1, RICi-T1

Fast Ethernet over E1/T1



The RICi-E1 and RICi-T1 are network termination units (NTUs) connecting Fast Ethernet over framed or unframed E1/T1 circuits.

The devices are deployed in point-to-point or hub-and-spoke topologies, working opposite RAD's RICi-16 Ethernet over TDM gateway. This enables carriers and service providers to extend their customer reach and utilize legacy PDH infrastructure in delivering new Ethernet services. Typical applications include Ethernet access, backhauling network management traffic and connecting inter-office or enterprise LAN segments.

- 10/100BaseT user port
- Single E1, T1 network port
- PDH to Ethernet fault propagation and TDM loop detection
- Interoperable with third-party devices: Supports standard GFP (ITU-T G.8040) and HDLC
- QoS priority queues
- Plug-and-play functionality using DHCP client
- Remote diagnostic tools on TDM and Ethernet ports
- Managed via SNMP, web server or Telnet

A

B

C

D

E

F

G

H

I

J

K

L

M

N

O

P

Q

R •

S

T

U

V

W

X

Y

Z

## • R/S

### ROC-19, ROC-19L Outdoor Cabinets



ROC-19 and ROC-19L are self-contained outdoor cabinets for housing a single 19"-wide RAD unit and a cabling system for various telecom services. Constructed for outdoor use, the enclosure is powered from a DC power source and is ideal for service providers that require efficient environmental isolation for their equipment.

The ruggedized IP56 (ROC-19) and IP66 (ROC-19L) NEMA-4-rated construction includes a rain hood, offering full shielding and protection against dust, rain and ice. Efficient ventilation is assured by an intake fan with replaceable air filters (ROC-19) or passive convection (ROC-19L). Secure, efficient maintenance and access are offered by a 2-point (ROC-19L) or 3-point (ROC-19) door locking mechanism, as well as an integrated fiber cable splicer/guide system, intrusion detection and over-current protection.

- Outdoor cabinet for one 19"-wide RAD unit, with integrated fiber splicer and guides
- IP56-66 NEMA-4-rated metal enclosure
- 24V DC or 48V DC powered
- Effective grounding and over-current protection
- 2- or 3-point door locking
- Intake fan with replaceable filters, or passive cooling
- Wall or pole mounting options

### SecFlow-1p Ruggedized IIoT Gateway

Hot Product



The compact SecFlow-1p is an entry-level multiservice gateway, for cost-effective industrial IoT backhaul. Housed in a ruggedized enclosure, it runs the advanced vCPE-OS operating system. The SecFlow-1p allows secure connectivity over wireless or fiber networks for all types of industrial devices, including RTUs, smart meter aggregation devices, IoT base stations or concentrators, CCTV cameras, point-of-sale devices, and more. RADview's security information and event management (SIEM) enables collection of all security events detected in the network. The system collects events from SecFlow devices and displays them visually on customizable dashboards.

- vCPE-OS operating system hosting of third-party software using Linux LXD container technology
- Multiservice support: GbE copper and fiber, serial RS-232/485
- Connectivity to remote and isolated sites using a dual SIM
- Single cellular modem for a 2G/3G/HSPA+/HSDPA/LTE uplink; dual SIM for always-on connectivity
- WiFi connectivity as access point
- Dynamic routing with OSPF, BGP, VRF and secure VPN using IPsec, DMVPN and NAT for flexible connectivity
- Cyber security suite: 802.1X, IPsec encryption with automated PKI, stateful firewall
- Serial protocol handling with transparent tunneling/protocol conversion/terminal server for IEC 60870-5-101, IEC 60870-5-104, Modbus RTU to Modbus TCP, and DNP3.0 RTU to TCP
- Zero-touch provisioning, firewall configuration, fault management and reporting, bulk software upgrade, and database management using RADview
- SD-CloudAccess agent support

## SecFlow-1v

### Ruggedized Multiservice IloT Gateway

Hot Product



The compact SecFlow-1v is a ruggedized multiservice gateway, featuring built-in security mechanisms designed for applications controlling mission-critical operations. It is ideal for industrial IoT backhaul, enabling fast, secure and economical deployment of new IoT sites. Allowing secure connectivity over wireless or fiber networks – either public (e.g., cellular) or private, it connects all types of industrial devices, including RTUs, smart meter aggregation devices, IoT base stations or concentrators, CCTV cameras, point-of-sale devices, WiFi base stations, and more. RADview's security information and event management (SIEM) enables collection of all security events detected in the network. The system collects events from SecFlow devices and displays them visually on customizable dashboards.

SecFlow-1v provides reliable and secure Layer 3 communications for power utilities, water and gas utilities, public safety and homeland security agencies, as well as intelligent transportation operators.

- **Hosting of third-party software using container technology**
- **Multiservice support: GbE copper and fiber, serial RS-232/485, Power over Ethernet (PoE)**
- **Single or dual cellular modem for a 2G/3G/HSPA+/HSDPA/LTE uplink, dual SIM**
- **WiFi connectivity as access point**
- **Dynamic routing with OSPF, BGP, VRF and secure VPN using IPsec, DMVPN and OpenVPN for flexible connectivity**
- **Cyber security suite: 802.1X, IPsec encryption with automated PKI, stateful firewall**
- **Serial protocol handling with transparent tunneling/protocol conversion/terminal server for IEC 60870-5-101, IEC 60870-5-104, Modbus RTU to Modbus TCP, and DNP3.0 RTU to TCP**
- **Zero-touch provisioning, firewall configuration, fault management and reporting, bulk software upgrade, and database management using RADview**
- **Digital and analog IOs with integrated RTU/PLC functionality**
- **LoRaWAN gateway for remote sensors aggregation**
- **Complies with IEC 61850-3 and IEEE 1613 and EN 50121-4**

## SecurityGateway

### VPN Aggregator, Router and Firewall

Hot Product



SecurityGateway is a major building block of RAD's industrial IoT solution, serving as a state-of-the-art VPN aggregation appliance. In the fast growing market of IloT and the need for secure communications, SecurityGateway provides a small form-factor yet powerful and cost-effective solution for aggregating traffic from multiple remote IloT sites.

SecurityGateway aggregates multiple VPNs from remote SecFlow devices and addresses industrial IoT applications, for example:

- Distributed automation in secondary substations
- Smart meter concentration
- Water resources management
- Smart retail

Typically located behind the organizational firewall, SecurityGateway may also serve as a WAN gateway, depending on customer needs. RADview's security information and event management (SIEM) enables collection of all security events detected in the network. The system collects events from SecFlow devices and displays them visually on customizable dashboards.

- **Compact 19" 1U VPN aggregation device supporting L2/L3 VPNs**
- **Optional high availability**
- **Feature-rich, dual stack IPv4/IPv6, including static and dynamic routing and NAT**
- **Stateful firewall, IKE1 and IKE2, automated PKI (X.509) with integrated DNS resolver**
- **Supports flexible connectivity methods such as encrypted IPsec VPN, OpenVPN and L2TP**
- **User authentication using RADIUS**
- **L2 functionality**
- **User-friendly, easy-to-use web-based GUI**
- **Fault management and reporting using RADview**

A

B

C

D

E

F

G

H

I

J

K

L

M

N

O

P

Q

R

S •

T

U

V

W

X

Y

Z

• S/V

**SFP/XFP/SFP+ Transceivers**

Small Form-Factor Pluggable Transceivers



RAD's SFP/XFP/SFP+ small form-factor pluggable transceivers are hot-swappable, input/output transceiver units converting optical and electrical media. Providing a wide range of detachable interfaces to multimode/single-mode optic fibers and UTP/coaxial electrical cables, RAD's miniature transceiver units enable significant savings in system maintenance and upgrade costs, as well as facilitate efficient design of host devices and flexible network planning.

It is strongly recommended to order RAD devices with original RAD SFP/XFP/SFP+ transceivers installed to ensure that the entire assembled unit has undergone comprehensive functional quality tests. RAD cannot guarantee full compliance to product specifications for units using non-RAD SFP/XFP/SFP+ pluggable transceivers.

**Optical SFPs**

- **MSA (multi-source agreement) compliant**
- **Built-in DDM (digital diagnostic monitoring) function**

**Smart SFPs**

- **GPON OLT in an SFP**
- **VDSL2 SFP**

**vCPE-OS**  
Open Carrier-Class Operating System for Network Edge Virtualization

Hot Product



Part of RAD's vCPE Toolbox, the Linux-based, carrier-class vCPE-OS runs on any white box server and is pre-loaded in RAD's virtual CPE (vCPE) platforms. It combines powerful networking capabilities with virtualization for hosting and accelerating SD-WAN and any other value-added virtual network function (VNF) applications from any vendor.

- **Slim, high performance operating system for optimized vCPE**
- **Open solution, compatible with any VNF (networking, security and IT), orchestrator and SDN controller**
- **Any access with advanced transport/networking capabilities: LTE, WiFi, Carrier Ethernet, xDSL, PON, and TDM**
- **High availability: Performance monitoring, troubleshooting and self healing - TWAMP, ICMP Echo, UDP Echo**
- **Any hardware: RAD's white box, gray box platforms, third-party servers, and RAD's pluggable PNFs**
- **Comprehensive management and security suite**
  - NETCONF/YANG, CLI, Syslog, alarms, and more
  - SNMPv3, SSH, SFTP, Access Control, TACAS+, RADIUS
  - Zero-touch and call-home provisioning
- **SD-CloudAccess agent support**



## vSD-WAN

Virtualized Networking Function for SD-WAN-Based Business Services by Versa Networks



The vSD-WAN by Versa Networks is a virtualized network function (VNF) that applies software-defined networking (SDN) to WAN connections. Featuring both networking and security functions in a single software, it is used to connect enterprise branch offices and data centers at a lower cost compared to IP VPNs. vSD-WAN offers multi-tenancy and high availability to optimize cost/performance of end-customer services. It features distributed network service functions to provide the flexibility and elasticity for easy, highly scalable and secure deployments. In addition, self-provision and self-care capabilities transform the customer experience. vSD-WAN is part of RAD's vCPE Toolbox. It can be hosted as a VNF on RAD's vCPE-OS and deployed with any ETX platform, as well as any supporting white box. This allows service providers to expand their managed services portfolio with a simplified and unified architecture.

- Zero-touch provisioning
- Multi-tenant support
- Application awareness, QoS
- Flexible deployment options: Bare metal, gray box and VNF
- Advanced routing: VRRP, IPAM, OSPF/BGP/MP-BGP/PBR, segment routing, MPLS L3 VPN and L2 VPN, QoS
- Security capabilities with UTM: Stateful firewall, DDoS prevention, malware protection, IPS-IDS, IPsec, antivirus, user and group authentication, URL and file filtering
- Visibility and analytics
- WAN optimization

A

B

C

D

E

F

G

H

I

J

K

L

M

N

O

P

Q

R

S

T

U

V •

W

X

Y

Z



# RAD Services





## RAD Global Services

### Peace of Mind, Where and When You Need It

RAD's Service Assured Access (SAA) and Service Assured Networking (SAN) solutions are all about enabling service providers and network operators to deliver the best possible service experience and seamlessly migrate to next-generation networks – all while increasing operational efficiency and reducing TCO.

Complementing these offerings are RAD Global Services, a great resource developed specifically to help our customers receive the full benefits of our solutions with real-time service guidance, planning and preventive maintenance.

RAD Global Services provide expert consulting and troubleshooting assistance, online tools, regular training programs, and various equipment coverage options – all designed to enable seamless installations and faster service rollouts. Moreover, our RAD programs help service providers to meet their SLAs and avoid penalties, while private network operators can rely on full support for their mission-critical applications.

These vital services are available from authorized RAD Partners and backed by highly dedicated and professional teams at regional technical assistance centers, together with project management staff and international training professionals.



## RADcare Technical Support

### Partner Benefits

- Strict service level agreements (SLAs): Receive response, restore service and resolve issues within a known and guaranteed time frame
- Move to the head of the queue with priority handling by RAD support centers and round-the-clock access to RAD's experts
- Free access to RADcare Online, including regular software updates and patches, online/remote configuration assistance and RAD's FAQ knowledge base

### Customer Benefits

- Ensure optimal quality of experience for your customers by maintaining a high quality network
- Meet your SLAs and avoid penalties by minimizing service outages and enabling fast recovery
- Plan ahead to limit your spending on support and eliminate hardware repair costs related to old equipment
- Shorten time to market (TTM): Rely on RADcare to support your operations so you can turn up new services faster

# RAD Global Services



- Guidance throughout design and rollout
- High- and low-level network design
- Support service migration and network upgrades
- On-site services
- Consulting services



- Project coordination
- Single point of contact
- Periodic meetings and progress reports
- Project-specific documentation



- Training-on-demand
- Regional sales, pre-sales and technical seminars
- RAD certification



- Strict SLA commitments on response, service restore and resolution times
- 24x7 support, priority handling and escalation procedures
- RADcare Online portal for software updates and upgrades
- Optional multi-year blanket coverage



## Project Assured Services

RADpro Project Assured services encompass all relevant aspects of the pre-installation design and rollout stages to get the new network up and running as quickly and as seamlessly as possible while providing additional vital benefits.

RADpro Project Assured services include the following valuable elements:  
**Planning • Staging • Site Survey • Equipment and Management Installation • Acceptance Testing and Commissioning • Resident Engineer**



## Project Assured Services

Enjoy full project assured service led by certified RAD engineers who are committed to your project's success from start to finish. RAD offers different project assured packages which include:

- High-level design (HLD): Thorough review of the physical topology, required hardware and software, and network management
- Low-level design (LLD): A definitive reference for system and network implementation, including detailed configuration instructions for devices, network management system and interfaces
- Configuration and testing performed by RAD experts to ensure ideal turn-up time
- Full documentation of your system's installation requirements for easier maintenance and future changes
- Commissioning design and execution so that the entire network can be certified before sign-off



## Project Management

RAD's professional Project Management staff ensures that your project will have a timely and smooth implementation from the planning stage through completion.

- A single point of contact (Project Manager) within RAD supervises all logistical, technical and commercial aspects of the implementation of all network solutions under your contract
- Periodic status meetings
- Detailed project plan procedures and documentation, regular progress reports, and management of all project aspects



## Training Center

RAD's training programs are designed to keep your team up-to-date with the latest RAD solutions.

- Technical seminars, web-based training and project-based training: A variety of on-site and remote interactive training options to ensure your engineers master your RAD equipment
- Course materials include a carefully balanced mix of lecture, demonstration and hands-on experience
- Topics include theory, configuration and troubleshooting



**RADadvantage**  
*Partners Program*



# Welcome to the RADadvantage Partners Program

---

Commitment. Trust. Respect. Partnership. These are just some of the values that comprise the essence of RADadvantage, RAD's channel partner program. Ultimately, the success of a partnership is measured by the benefits that are enjoyed by all parties:

The vendor, its partners, and their respective end-users. That's why RAD places immense importance on its network of channel partners and invests significantly in partner enablement, engagement and support.

## Shared Interests and Commitments

---

RAD and its channel partners embrace a set of fundamental guiding principles:

- Delivering the highest quality products, solutions and services that create loyal end-users
- Maximizing customer satisfaction
- Conducting business in an atmosphere of trust and mutual respect
- Resolving problems with candor and good judgment
- Cooperating to win new business and improve existing opportunities

## RADadvantage Program Highlights

---

The RADadvantage Partners Program is designed to incrementally reward partners based on achievements in annual revenues, service level accreditation and commitment. Designated partnership levels are reviewed and adjusted annually.

RADadvantage Partners enjoy benefits such as:

- Joint business development efforts
- Online and face-to-face sales and technical training programs
- Support for co-branded marketing activities
- Official acknowledgement of Partner relationship



# Welcome to RADacademy



RADacademy equips RAD Partners with the knowledge they need in order to sell, demonstrate, install, and support RAD's solutions for service providers and critical infrastructure.

## »Our Goals

- Present the unique value of our solutions, using the latest presentations and sales tools
- Deliver the know-how to sell, install and support our solutions
- Ensure that knowledge transfers from RAD to Partners globally, on a quick and consistent basis

## »Sales Training and Certification

This program is based on remote and face-to-face training for new Partners/new personnel, followed by ongoing web-based training (WBT). Solution Partners must attend the majority of the relevant WBT sessions.

## »Technical Training and Certification

This program begins with the technical seminars, where RAD's trainers introduce the latest features and functions. Some WBT sessions serve this purpose as well.

## »Web-Based Training (WBT)

RADacademy's WBT is a popular, long-running program of weekly update WBT classes for RAD Partners, covering everything from product updates to the latest technology developments. During these live sessions, the participants are encouraged to ask questions, engage with our subject matter experts and share their success stories. There is also access to RAD's WBT archive where previous sessions are available for viewing.

## »End-User Project-Based Training

One of the main ingredients for a successful installation is the transfer of knowledge to the user.

RAD offers direct training to end-users, arranged via RAD Partners, on-site or at RAD headquarters. Our trainers' expertise will ensure that the implementation of RAD's solutions will be as smooth as possible.

In addition to classroom training (either on-site or at a RAD office), we also offer training via WBT.

» For more information, please contact [training@rad.com](mailto:training@rad.com)



[www.rad.com](http://www.rad.com)

Specifications are subject to change without prior notification. The RAD name and logo are registered trademarks of RAD Data Communications Ltd. RAD product names are trademarks of RAD Data Communications Ltd. ©2022 RAD Data Communications. All rights reserved. Version 01/22

## RAD Group

RAD is the anchor of the \$1.5 billion RAD Group of companies, a world leader in communications solutions. A unique business philosophy distinguishes the RAD Group, which has incubated hundreds of Israeli start-ups since its inception. Each company in the RAD Group operates autonomously under a common strategic umbrella. This decentralized approach maximizes the advantages inherent in small business units, such as flexibility, entrepreneurial spirit and management focus. The companies coordinate strategy, sales channels and R&D efforts. Four RAD Group companies are currently traded on the Nasdaq Stock Market in the US, while the others are privately held by the group's founders and various venture capital firms.

## RAD Worldwide Offices

### North American Headquarters

900 Corporate Drive, Mahwah, NJ 07430, USA  
Tel 1-201-529-1100 | Toll free 1-800-444-7234 | Fax 1-201-529-5777  
Email [market@radusa.com](mailto:market@radusa.com)

### International Headquarters

24 Raoul Wallenberg Street, Tel Aviv 6971923, Israel  
Tel 972-3-6458181  
Email [market@rad.com](mailto:market@rad.com)



Your Network's Edge®

